















INDUSTRIES, INC.

Quality Products for the Fence Industry Since 1985

PRODUCT CATALOG

Version 25

CONTENTS

-  [4 Gate Latches: Auto-Latch, MagnaLatch®](#)
-  [6 Gate Latches: Strong-Arm](#)
-  [8 Cantilever Gate Rollers](#)
-  [10 Gate Hinges: Gravity, TruClose®](#)
-  [12 Gate Hinges: ShutIt®, SureClose®](#)
-  [14 Gate Hinges & Closers: Locinox®, LockeyUSA™](#)
-  [16 Panic Exit Hardware: Device Only](#)
-  [18 Panic Exit Hardware: Accessories](#)
-  [22 Panic Exit Hardware: Full Kit, Exit Only](#)
-  [24 Panic Exit Hardware: Full Kit with Re-Entry](#)
-  [26 Panic Exit Hardware: Outside Trim](#)
-  [30 Standalone Lever Lock Kits](#)
-  [34 Gate Accessories](#)



Round Profile



Square Profile



Round Adapter Available



Welding Required



Scan to Download a Digital
Version of the Catalog or
View Installation Videos

Information is accurate at the time of print. Please visit our website for the most current catalog.

Table of Contents



Latches

Hardware Bags & Signs

- Replacement Hardware for the Auto-Latch
- Includes Two Brackets with Nuts and Bolts, plus Two Carriage Bolts with Washers and Nuts

Description	Part no.	Weight ea.	Price
Sign - with Instructional Diagram	Sign - Auto-Latch		
1 3/8" Gate Frame	AL Bag 1	.4 lbs.	
1 5/8" Gate Frame	AL Bag 2	.4 lbs.	
2" Gate Frame	AL Bag 3	.4 lbs.	



Auto-Latch Gate Stop

Metal Gate Stop for Auto-Latch

- Black Finish
- Prevents Gate From Swinging Both Ways
- Residential will fit 1 3/8" Frame / Commercial will fit 1 5/8" or 2" Frame.

Description	Part no.	Weight ea.	Price
Residential Gate Stop	1599	.65 lbs.	
Commercial Gate Stop	1560	.65 lbs.	



1499 Mini-Latch

1 3/8" Round Gate Frame

- Short Handle, Ideal for Kennels
- Child-Resistant
- Self-Latching
- Allows Gate to Swing Both Ways
- Can be Padlocked from Either Side
- Fixed 2" Gap
- Fits 1 3/8" Gate Post; Available for 2" or 2 1/2" Gate Post Upon Request

Description	Part no.	Weight ea.	Price
1 3/8" Short Handle	1499	.95 lbs.	



Residential Auto-Latch*

1 3/8" Round Gate Frame

- Child-Resistant
- Self-Latching
- Allows Gate to Swing Both Ways
- Can be Padlocked from Either Side
- Fixed 2" Gap

Mix any size latch for price break. Sold individually or 10 or 25/box

Description	Part no.	Weight ea.	Price
1 3/8" x 1 3/8"	1500	1.3 lbs.	
1 3/8" x 2"	1502	1.3 lbs.	
1 3/8" x 2 1/2"	1525	1.3 lbs.	
1 3/8" x 3"	1527	1.3 lbs.	

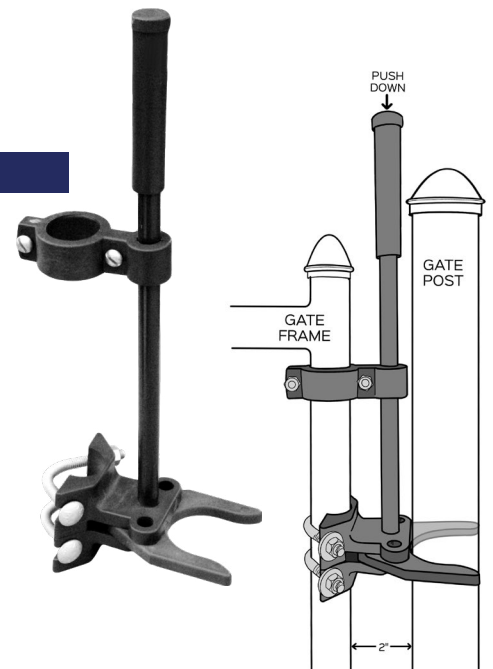

*When installed properly, these latches meet Consumer Product Safety Commission guidelines for swimming pool latches.

● Commercial Auto-Latch*

1 5/8" or 2" Round Gate Frame

- Child-Resistant
- Self-Latching
- Allows Gate to Swing Both Ways
- Can be Padlocked from Either Side
- Fixed 2" Gap

Mix any size latch for price break. Sold individually or 10 or 25/box

Description	Part no.	Weight ea.	Price
1 5/8" x 2"	1562	1.35 lbs.	
1 5/8" x 2 1/2"	1565	1.35 lbs.	
1 5/8" x 3"	1567	1.40 lbs.	
2" x 2"	1572	1.40 lbs.	
2" x 2 1/2"	1575	1.40 lbs.	
2" x 3"	1577	1.45 lbs.	

■ Square Auto-Latch*

Designed for Ornamental Fences

- Child-Resistant
- Self-Latching
- Allows Gate to Swing Both Ways
- Can be Padlocked from Either Side
- Fixed 3" Gap

Description	Part no.	Weight ea.	Price
1" x 1 1/2"	2015	1.9 lbs.	
1" x 2"	2020	1.9 lbs.	
1" x 2 1/2"	2025	1.9 lbs.	
1 1/4" x 1 1/2"	2215	1.9 lbs.	
1 1/4" x 2"	2220	1.9 lbs.	
1 1/4" x 2 1/2"	2225	1.9 lbs.	
1 1/2" x 1 1/2"	2515	1.9 lbs.	
1 1/2" x 2"	2520	1.9 lbs.	
1 1/2" x 2 1/2"	2525	1.9 lbs.	
Adapter Kit	2999	.9 lbs.	

Adapter Kit includes: 1" and 1 1/4" inserts, 1 1/2", 2" and 2 1/2" collars

◆ D&D Technologies® MagnaLatch®*

- Child-Resistant
 - Industry Leading Magnetic Latching Technology
 - 6-Pin Re-Keyable Security Lock Included (KW5)
 - Adapts to All Square Frame Gates
 - Optional Round Post Adaptor Kit Allows for Fitting to Round Posts
 - Adjusts for 1/2" to 1 1/2" Gap. 1 1/4" – 2 1/4" Gap with Round Post Adapter Added
- Sold Individually or 15/box

Description	Part no.	Weight ea.	Price
MagnaLatch® Series 3 Top Pull	ML3TPKA	1.71 lbs.	
MagnaLatch® Series 3 Vertical Pull	ML3VPKA	1.71 lbs.	
Round post adapter kit	ML3RPK	.54 lbs.	



D® Authorized distributor.
Contact us for a full list of in-stock products.

To order call 616.235.0140
Email: info@dacindustries.com

● 4138 Residential Strong Arm

1 3/8" Strong Arm Latch for Round Frame

- For Double Drive Gates
- Steel Latch
- Galvanized or Black Powder Coat Finish
- Adjusts for 2" to 4" Gap

Sold Individually or 12/box.

Description	Part no.	Weight ea.	Price
1 3/8" Round Frame - Galvanized	4138	2.9 lbs.	
1 3/8" Round Frame - Black	4138-B	2.9 lbs.	



● 4000 Commercial Strong Arm

1 5/8" or 2" Strong Arm Latch for Round Frame

- For Double Drive Gates
- Heavy Duty Steel Latch
- Galvanized or Black Powder Coat Finish
- Fits 1 5/8" or 2" Gate Frame
- Adjusts for 2 1/2" to 6" Gap

Sold Individually or 6/box.

Description	Part no.	Weight ea.	Price
1 5/8" or 2" Round Frame - Galvanized	4000	9 lbs.	
1 5/8" or 2" Round Frame - Black	4000-B	9 lbs.	



● Walk Gate Strong Arm

1 5/8" or 2" Walk Gate Latch for Round Frame

- Heavy Duty Steel Latch
- Galvanized or Black Powder Coat Finish
- Adjusts for 2 1/4" to 5" Gap (2 1/2" min for 4658)
- Available for 2 1/2", 3", 4", 4 1/2" or 6 5/8" Round Post

Sold individually or 10/box

Description	Part no.	Weight ea.	Price
2 1/2" Round Post			
Galvanized	4250	4.5 lbs.	
Black	4250-B	4.5 lbs.	
3" Round Post			
Galvanized	4300	4.5 lbs.	
Black	4300-B	4.5 lbs.	
4" Round Post			
Galvanized	4400	4.5 lbs.	
Black	4400-B	4.5 lbs.	
4 1/2" Round Post			
Galvanized	4450	4.5 lbs.	
Black	4450-B	4.5 lbs.	
6 5/8" Round Post			
Galvanized	4658	5 lbs.	
Black	4658-B	5 lbs.	



4090 Commercial Strong Arm

2" Strong Arm Latch for Square Frame

- For Double Drive Gates
 - Heavy Duty Steel Latch
 - Galvanized or Black Powder Coat Finish
 - Adapters Available for use on 1 3/4" or 1 1/2" Square Frame
 - Adjusts for 2 1/2" to 3 1/4" Gap
- Sold individually or 6/box*

Description	Part no.	Weight ea.	Price
2" Square Frame - Galvanized	4090	7 lbs.	
2" Square Frame - Black	4090-B	7 lbs.	



Walk Gate Strong Arm

2" Walk Gate Latch for Square Frame

- Heavy Duty Steel Latch
 - Galvanized or Black Powder Coat Finish
 - Adapter Available for use on 1 3/4" or 1 1/2" Square Frame
 - Adjusts for 3" to 5" Gap - *3 5/8" Minimum for Ornamental Aluminum
 - Available for 2 1/2", 3", 4", 4 1/2" or 6" Square Post
- Sold individually or 10/box*

Description	Part no.	Weight ea.	Price
2 1/2" Square Post			
Galvanized	4290	4 lbs.	
Black	4290-B	4 lbs.	
3" Square Post			
Galvanized	4390	4 lbs.	
Black	4390-B	4 lbs.	
4" Square Post			
Galvanized	4490	4 lbs.	
Black	4490-B	4 lbs.	
4 1/2" Square Post			
Galvanized	4455	4 lbs.	
Black	4455-B	4 lbs.	
6" Square Post			
Galvanized	4690	5 lbs.	
Black	4690-B	5 lbs.	



Accessories

- Adapters for Square Frame (Double Drive Latches Require Two)
- Replacement Hardware for Strong Arm Latches

Description	Part no.	Weight ea.	Price
1 1/2" Adapter	4950	1 lb.	
1 3/4" Adapter	4999	.5 lb.	
Hardware Bags			
Residential DD	SA Bag Res DD	.5 lb.	
Commercial DD Round	SA Bag	.5 lb.	
Commercial DD Square	SA Bag SQ	.5 lb.	
Walk Gate Round	SA WG Bag	.5 lb.	
Walk Gate Square	SA WG Bag SQ	.5 lb.	



7000 Sentry Latch

Ideal for Dumpster Gates

- Access from One Side Only
 - Black Powder Coat Finish
 - Adjusts for 1" to 2 1/2" Gap
 - 5/16" x 3 1/2" Stainless Steel Machine Screws Included
 - Use on Steel, Wood on Steel, Ornamental, Polyvinyl and Wood Gates
- Sold individually or 10/box*

Description	Part no.	Weight ea.	Price
Sentry Latch	7000	4.75 lbs.	



Cantilever Rollers

● 5200

Roll Gate Track Roller with Bracket Assembly | Nylon

- Wheel Diameter 4"
- Frame Pipe Size 1 5/8" or 2" O.D.
- Fits 1 5/8" O.D. Track



Description	Part no.	Weight ea.	Price
Roll Gate Track Roller	5200	5 lbs.	

■ 5350

Square Stealth Cantilever Gate Roller Assembly | Graphite Impregnated Nylon

- 2" Square Pipe Roller
 - UV Inhibitors
 - 2,200 lb. Load Rating on Single Bearing; 3,500 lb. Load Rating on Double Bearing
- Sold individually or 4/box.*

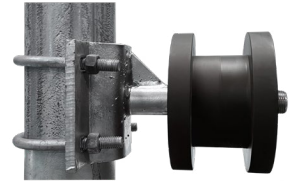

5350

Description	Part no.	Weight ea.	Price
Single Bearing			
2" Sq. Gate Frame - 4" Rnd. Post	5350	11 lbs.	
2" Sq. Gate Frame - 3" Rnd. Post	5350-3	11 lbs.	
2" Sq. Gate Frame - 3" Sq. Post	5350-3S	11 lbs.	
2" Sq. Gate Frame - 4" Sq. Post	5350-4S	11 lbs.	
Double Bearing			
2" Sq. Gate Frame - 4" Rnd. Post	5350-HD	12 lbs.	
2" Sq. Gate Frame - 3" Sq. Post	5350-3SHD	12 lbs.	
2" Sq. Gate Frame - 4" Sq. Post	5350-4SHD	12 lbs.	
2" Sq. Gate Frame - 6" Sq. Post	5350-6S	14 lbs.	

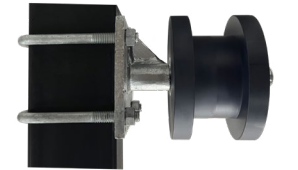

5350-4S

● 5500

Round Stealth Cantilever Gate Roller Assembly | Graphite Impregnated Nylon

- 2" Round Pipe Roller
 - UV Inhibitors
 - 2,200 lb. Load Rating
- Sold individually or 4/box.*

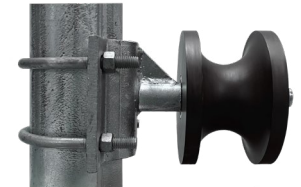

5500

Description	Part no.	Weight ea.	Price
2" Rnd. Gate Frame - 4" Rnd. Post	5500	11 lbs.	
2" Rnd. Gate Frame - 3" Rnd. Post	5500-3	11 lbs.	
2" Rnd. Gate Frame - 3" Sq. Post	5500-3S	11 lbs.	
2" Rnd. Gate Frame - 4" Sq. Post	5500-4S	11 lbs.	

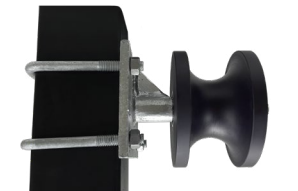

5500-4S

■ Cantilever Roller Gate Stop

● Metal Gate Stop

- Galvanized Finish
- Designed for Stealth Rollers
- Installs with Roller Hardware

Description	Part no.	Weight ea.	Price
Metal Gate Stop	CR Gate Stop	2.10 lbs.	



• Custom size rollers available

● 5800

Round Stealth Cantilever Gate Roller Assembly | Graphite Impregnated Nylon

- 2 1/2" Round Pipe Roller
 - UV Inhibitors
 - 2,200 lb. Load Rating on Single Bearing; 3,500 lb. Load Rating on Double Bearing
- Sold individually or 4/box.*

Description	Part no.	Weight ea.	Price
Single Bearing			
2 1/2" Rnd. Gate Frame - 4" Rnd. Post	5800	11 lbs.	
2 1/2" Rnd. Gate Frame - 3" Rnd. Post	5800-3	11 lbs.	
2 1/2" Rnd. Gate Frame - 3" Sq. Post	5800-3S	11 lbs.	
2 1/2" Rnd. Gate Frame - 4" Sq. Post	5800-4S	11 lbs.	
Double Bearing			
2 1/2" Rnd. Gate Frame - 4" Rnd. Post	5800-4HD*	12 lbs.	
2 1/2" Rnd. Gate Frame - 3" Rnd. Post	5800-3HD	12 lbs.	
2 1/2" Rnd. Gate Frame - 3" Sq. Post	5800-3SHD	12 lbs.	
2 1/2" Rnd. Gate Frame - 4" Sq. Post	5800-4SHD	12 lbs.	

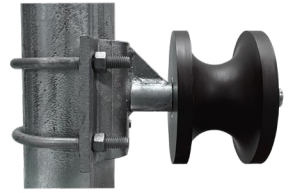

5800

* Available as a Double Roller



● 5658

Round Stealth Cantilever Gate Roller Assembly | Graphite Impregnated Nylon

- 2 1/2" Round Pipe Roller
 - UV Inhibitors
 - Double Bearings
 - Load Rating 3,500 lbs.
- Sold individually or 4/box.*

Description	Part no.	Weight ea.	Price
2 1/2" Rnd. Gate Frame - 6 5/8" Rnd. Post	5658*	15 lbs.	

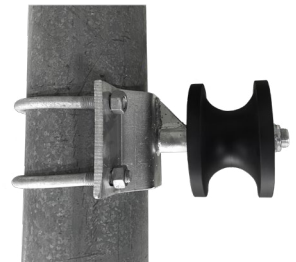

5658

● 5858

Round Stealth Cantilever Gate Roller Assembly | Graphite Impregnated Nylon

- 2 1/2" Round Pipe Roller
 - UV Inhibitors
 - Double Bearings
 - Load Rating 3,500 lbs.
- Sold individually or 4/box.*

Description	Part no.	Weight ea.	Price
2 1/2" Rnd. Gate Frame - 8 5/8" Rnd. Post	5858*	17 lbs.	



■ 5950

Stealth Roller Cover | Tough Polyethylene Plastic

- UV Inhibitors
- Custom Fit for DAC Stealth Roller

Description	Part no.	Weight ea.	Price
Roller Cover - Top	5950-T	1.4 lbs.	
Roller Cover - Bottom	5950-B	1.2 lbs.	

● 5975

Universal Roller Cover | Tough Polyethylene Plastic

- UV Inhibitors
- Bracket Clamps Behind Roller Chassis
- For Round Post

Description	Part no.	Weight ea.	Price
Roller Cover - Top	5975-T	2.1 lbs.	
Roller Cover - Bottom	5975-B	2.1 lbs.	



Hinges & Closers

Residential Self-Closing Gravity Hinge Sets

1 3/8" Round Gate Frame

- Self-Closing & Self-Rising
- Compatible with Self-Latching Hardware
- One-Way Hinge Allows Gate to Swing in Only One Direction
- Two-Way Hinge Allows Gate to Swing Both In AND Out
- 2 1/4" Fixed Gap

Mix any size for price break. Sold individually or 10/bag.

Description	Part no.	Weight ea.	Price
One-Way			
2" Gate Post	1602-OW	3.2 lbs.	
2 1/2" Gate Post	1625-OW	3.3 lbs.	
3" Gate Post	1627-OW	3.5 lbs.	
Two-Way			
2" Gate Post	1602	3.2 lbs.	
2 1/2" Gate Post	1625	3.3 lbs.	
3" Gate Post	1627	3.5 lbs.	



TWO-WAY



ONE-WAY

Commercial Self-Closing Gravity Hinge Sets

1 5/8" or 2" Round Gate Frame

- Self-Closing & Self Rising
- Compatible with Self-Latching Hardware
- One-Way Hinge Allows Gate to Swing in Only One Direction
- Two-Way Hinge Allows Gate to Swing Both In AND Out
- 2 1/4" Fixed Gap

Mix any size for price break. Sold individually or 10/bag.

Description	Part no.	Weight ea.	Price
One-Way			
1 5/8" x 2"	1662-OW	3.7 lbs	
1 5/8" x 2 1/2"	1665-OW	3.7 lbs.	
1 5/8" x 3"	1667-OW	3.8 lbs	
2" x 2"	1672-OW	3.8 lbs.	
2" x 2 1/2"	1675-OW	3.8 lbs.	
2" x 3"	1677-OW	3.9 lbs.	
Two-Way			
1 5/8" x 2"	1662	3.7 lbs	
1 5/8" x 2 1/2"	1665	3.7 lbs.	
1 5/8" x 3"	1667	3.8 lbs	
2" x 2"	1672	3.8 lbs.	
2" x 2 1/2"	1675	3.8 lbs.	
2" x 3"	1677	3.9 lbs.	

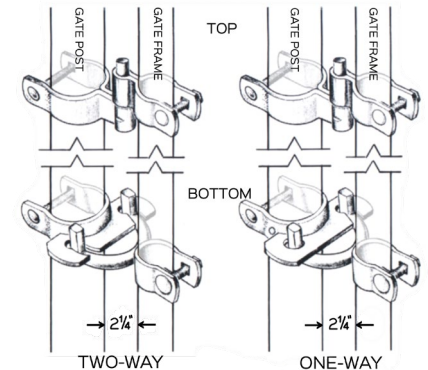

Sign

"Gate Swings Out" Sign

- For Use with One-Way Hinges

Description	Part no.	Weight ea.	Price
4" x 6" Sign - with Diagram	Sign-Hinge		



The gravity type self-closing hinge set has no springs to wear out. By raising the bottom hinge set you can increase the force at which the gate will close. The hinges can also be used to compensate for slight grade changes making it possible to install the gate on a hill, yet keep the bottom of the gate close to the ground.

■ TCA1 TruClose® Regular Duty Hinge

Pair Regular Duty TruClose® Hinges

- Self-Closing Max 66 lbs.
 - For Square Frame Metal Gates
 - Adjustable, Self-Closing Tension from Either End
 - No Visible Fasteners
 - “L2” Model Offers Quick-Fit Alignment Legs for Added Fitting Strength
- Sold individually or 20/box*

Description	Part no.	Weight ea.	Price
Regular Duty Without Legs	TCA1S3	.7 lbs.	
Regular Duty, 2 Legs	TCA1L2S3	.9 lbs.	



● TCHDRND TruClose® Heavy Duty Round Post Hinge

Pair Heavy Duty Round Post Hinges for Chain Link Gates

- Self-Closing Max 154 lbs.
 - Round Post Configuration
 - Convenient, Reliable Performance
 - Quick, Self-Closing Adjustment
 - Smooth, Even Closure
- Sold individually or 15/box*

Description	Part no.	Weight ea.	Price
1 3/8" & 1 5/8" O.D. Frame 2", 2 1/2" or 3" O.D. Post	TCHDRND1	2 lbs.	
2" O.D. Frame 2" or 3" O.D. Post	TCHDRND2	2 lbs.	



■ TCHD TruClose® Heavy Duty Hinge

Pair Heavy Duty TruClose® Hinges

- Self-Closing Max 154 lbs.
 - Convenient, Reliable Performance
 - Quick, Self-Closing Adjustment
 - Smooth, Even Closure
 - No Visible Fasteners
 - “L2” Model Offers Quick-Fit Alignment Legs for Added Fitting Strength
 - Standard and Alignment Legs Work Best with Ornamental Aluminum or Steel
- Sold individually or 20/box*

Description	Part no.	Weight ea.	Price
Heavy Duty Without Legs	TCHD1AS3	1.25 lbs.	
Heavy Duty, 2 Legs	TCHD1AL2S3	1.35 lbs.	



TruClose® MULTI-ADJUST™

Pair TruClose® Hinges with 3 Way Adjustment

- Vertical and Horizontal Adjustment. Adjustable Tension
 - Convenient, Reliable Performance
 - Smooth, Even Closure
 - TCAMA Mini Multi-Adjust™ Self-closes Wood and Vinyl Gates up to 55lb.
 - TCAMARND Mini Multi-Adjust™ Round Self-Closes Chain Link Gates up to 55 lbs. Fits Frame: 1 3/8" & 1 5/8" Post: 1 7/8"-2", 2 3/8" & 2 7/8"
 - TCHDMA1S3 Multi-Adjust™ Heavy Duty Self-closes wood and vinyl gates up to 154 lb.
- Mini Multi-Adjust sold individually or 25/box. Heavy Duty Multi-Adjust sold individually or 10/box*

Description	Part no.	Weight ea.	Price
Mini Multi Adjust™	TCAMA	1.25 lbs	
Mini Multi-Adjust™ Round	TCAMARND	1.35 lbs	
Multi-Adjust™ Heavy Duty	TCHDMA1S3	2.82 lbs	



8000

Single Bearing Hinge, Center Mount



- Ideal for Smaller Vehicular and Pedestrian Gates
- One Sealed Maintenance Free Bearing
- Zinc Plated Steel
- Adjustable for Easy Installation
- Ideal for Flat or Round Post
- Maximum Gate Weight 300 lbs.
- Sold Individually
- Non Self-Closing
- 2 1/2" - 3" Gap
- CI3600

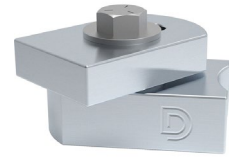

Description	Part no.	Weight ea.	Price
Single Bearing Hinge	8000	1 lb.	

8010

Standard Hinge, Center Mount



- Two Sealed Maintenance Free Bearings
- Zinc Plated
- Adjustable Yoke for Easy Installation
- Ideal for Flat or Round Post (Bolt-On for Flat Post)
- Sold Individually
- Non Self-Closing
- Gap for Weld-On 2 1/2" - 3"
- Gap for Bolt-On 2.9" - 3.4"
- CI3000 (Steel), CI3400 (Aluminum), CI3700 (Bolt-On)

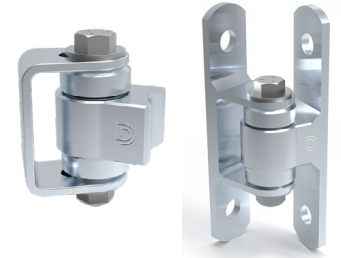

Description	Part no.	Weight ea.	Price
Steel - Max Gate Weight 1,100 lbs.	8010-S	2.5 lbs.	
Aluminum - Max Gate Weight 600 lbs.	8010-A	1.5 lbs.	
Bolt-On (Steel) - Max Gate Weight 1,000 lbs.	8010-BO	3.5 lbs.	
Bolt-On (Steel) Black - Max Gate Weight 1,000 lbs.	8010-BO-B	3.5 lbs.	

8015

Standard Hinge, Face Mount



- Opens 180° for Unobstructed Pass Through
- Zinc Plated (Available Black)
- Adjustable Yoke for Easy Installation
- Ideal for Flat Post
- Maximum Gate Weight 1,100 lbs.
- Sold Individually
- Non Self-Closing
- 1/2" - 1" Gap
- CI3050 (Weld-On) CI3720 (Bolt-On)

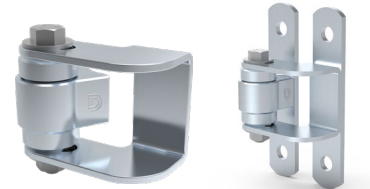

Description	Part no.	Weight ea.	Price
Weld-On (Steel) Face Mount	8015		
Bolt-On Face Mount	8015-BO	3.5 lbs.	
Bolt-On Face Mount - Black	8015-BO-B		

8020

Heavy Duty Hinge, Center Mount



- Three Sealed Maintenance Free Bearings
- Zinc Plated Steel
- Adjustable Yoke for Easy Installation
- Ideal for Flat or Round Post
- Maximum Gate Weight 1,500 lbs.
- Sold Individually
- Non Self-Closing
- 2 1/2" - 3" Gap
- CI3500



Description	Part no.	Weight ea.	Price
Heavy Duty Hinge	8020	2.5 lbs.	

CI Bolt Set

Installation Hardware for Bolt-On Hinges



- Stainless Steel Bolts, Washers, and Lock Nuts
- For 2" Frame, 3" or 4" Post
- One Bolt Set Provides Hardware for Two Individual Hinges OR One Self-Closing Set

Description	Part no.	Weight ea.	Price
Bolts for 3" Post	CI Bolt 3	1 lb.	
Bolts for 4" Post	CI Bolt 4	1 lb.	

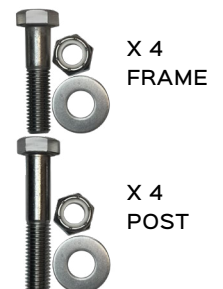

8030*

Self-Closing Hinge, Center Mount

- Two Sealed Maintenance Free Bearings
- Zinc Plated Steel
- Ideal for Flat or Round Post
- Maximum Gate Weight 1,100 lbs., Self-Closes up to 300 lbs.
- 5 Tension Adjustments
- Sold as a Pair; One Self-Closing Hinge and One Steel Hinge
- Weld-On or Bolt-On
- Gap for Weld-On 2 1/2" - 3"
- Gap for Bolt-On 2.9" - 3.4"
- CI3850 (Weld-On), CI3850R (WO Round), CI3860 (Bolt-On)
- ADA Suitable



Description	Part no.	Weight ea.	Price
-------------	----------	------------	-------

Self-Closing Hinge	8030	6 lbs.	
Self-Closing Hinge-Round	8030-R	6 lbs.	
Self-Closing Hinge-Bolt-On	8030-BO	9 lbs.	

8035*

Self-Closing Hinge, Face Mount

- Opens 180° for Unobstructed Pass Through
- Zinc Plated Steel
- 5 Tension Adjustment Settings
- Maximum Gate Weight 1,100., Self Closes up to 300 lbs.
- Sold as a Pair; One Self-Closing Hinge and One Steel Hinge
- 1/2" - 1" Gap
- CI3850FM (Weld-On) CI3860FM (Bolt-On)
- ADA Suitable



Description	Part no.	Weight ea.	Price
-------------	----------	------------	-------

Self-Closing WO FM	8035-WO	7 lbs.	
Self-Closing BO FM	8035-BO	10 lbs.	

*Self-Closing Hinges Also Available in HD; Self-Close Gates up to 440 lbs.

SureClose® ReadyFit Kit



- Externally Mounted
- Easy Install - No Special Tools or Holes in Post
- Multiple Adjustment Options: Self-Closing Speed and Force, Final Snap-Close Action, Horizontal Adjustment
- Hydraulic Dampened Closing
- Gap Variance of 1/2" To 1 3/8" (12-35mm)
- All Mounting Brackets and Fasteners Included
- Safety Gate (SF) Models Available, Gate Will Not Hold Open at 90°. Stop Included.

*One Kit Will Hang
One Gate*

Description + Part no.	Weight ea.	Price
------------------------	------------	-------

Screw On Aluminum

ReadyFit Kit (S) 108+SM	6 lbs.	
ReadyFit Kit (S) 108+108	7 lbs.	
ReadyFit Kit (S) 108SF+SM+Stop	9 lbs.	
ReadyFit Kit (S) 108SF+108SF+Stop	10 lbs.	

Weld On Steel

ReadyFit Kit (W) 108+SM	8 lbs.	
ReadyFit Kit (W) 108+108	9 lbs.	
ReadyFit Kit (W) 108SF+SM+Stop	11 lbs.	
ReadyFit Kit (W) 108SF+108SF+Stop	12 lbs.	

Hinge Combinations	Self-Closing Gate Weight Max
108 + SM	180 lbs (80 kgs)
108 + 108	260 lbs (120 kgs)

Access Control	Weight Capacity
SM + SM	1,500 lbs (680 kgs)

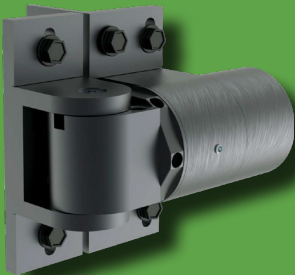

74108313T
RF 108 W Hinge Closer Alum.



74001313T
RF SM W Hinge Only Alum.



7403
RF Gate Stop
(Stop Included with SF Models Only)

To order call 616.235.0140
Email: info@dacindustries.com

◆ Caracal

Compact Gate Closer & Hinge

- Opening Angle: 180°
- Gates up to 132 lbs. and 4' Wide
- Hydraulic damping
- ADA Compliant
- One Caracal Closer Paired with One Serval Spring Hinge
- Round Post Adapter Available (CLB)

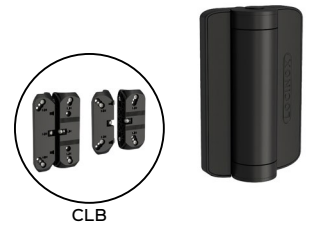

Description	Part no.	Weight ea.	Price
Caracal	Caracal	4 lbs.	
Caracal - Chain Link Bracket	Caracal CLB	1 lb.	

■ Verticlose-2

Hydraulic Vertical Gate Closer

- Opening Angle: 180°
- Gates up to 330 lbs. and 4' - 5' Wide
- Vertically Mounted
- Ideal in Combination with 90° or 180° Hinges
- ADA Compliant from 4' or more



Description	Part no.	Weight ea.	Price
Verticlose - Silver	Verticlose -S	12 lbs.	
Verticlose - Black	Verticlose -B	12 lbs.	

◆ SAMSON-2

Hydraulic Gate Closer

- Opening Angle: 150°
- Gates up to 330 lbs. and 3' - 6 1/2' Wide
- Horizontally Mounted
- ADA Compliant from 4' or more
- Round Post Adapter Available for 1 5/8" or 1 7/8" Gate Frame and 3" or 4" Gate Post

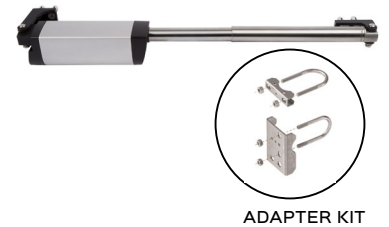

Description	Part no.	Weight ea.	Price
Samson-2	Samson-2	12 lbs.	
Round Post Adapter	Specify Size	2.75 lbs.	

◆ TIGER

Hinge and Gate Closer in One

- Opening Angle: 180°
- Gates up to 165 lbs. and 4' Wide
- Vertically Mounted (Hinge Included)
- ADA Compliant from 3' or more
- One Hydraulic, Self-Closing, Double Bearing Hinge Paired with One PUMA (Non-Self-Closing) Hinge
- Round Post Adapter Available (CLB)



Description	Part no.	Weight ea.	Price
TIGER - Silver	TIGER-S	6 lbs.	
TIGER - Black	TIGER-B	6 lbs.	
TIGER - Chain Link Bracket	TIGER-CLB	2.4 lbs.	

◆ MAMMOTH-180

Gate Closer and Hinge in One

- Opening Angle: 180°
- Gates up to 330 lbs. and 5' Wide
- Vertically Mounted (Hinge Included)
- ADA Compliant from 3' or more
- One Hydraulic, Self-Closing, Double Bearing Hinge Paired with One DINO (Non-Self-Closing) Hinge
- Round Post Adapter Available (CLB)



Description	Part no.	Weight ea.	Price
Mammoth - Silver	Mammoth-180-S	12 lbs.	
Mammoth - Black	Mammoth-180-B	12 lbs.	
Mammoth - Chain Link Bracket	Mammoth-180-CLB	4 lbs.	

■ MAMMOTH HD

Ultra Heavy Duty Gate Closer and Hinge in One

- Opening Angle: 180°
- Gates up to 440 lbs. and 6 1/2' Wide
- Vertically Mounted (Hinge Included)
- ADA Compliant from Gate Widths of 4.4' or more
- One Hydraulic, Self-Closing, Double Bearing Hinge Paired with One Raptor (Non-Self-Closing) Hinge



Description	Part no.	Weight ea.	Price
Mammoth HD - Silver	Mammoth-HD-S	14 lbs.	
Mammoth HD - Black	Mammoth-HD-B	14 lbs.	

Gate Closers

- For Left and Right Turning Gates
- Resistant to Temperature Changes
- For use on Square Profile Gates
- Chain Link Adapter Kits Available with SELECT Models

TB175

Garden Gate Closer

- Adjustable Closing Speed
- Hold Open Function
- Suitable for Wood or Metal Gates
- Maximum Gate Width 54"
- Maximum Gate Weight 125 lbs.

- Maximum Opening Angle of 90°
- Black Finish



Description	Part no.	Weight ea.	Price
Garden Gate Closer	TB175	2.5 lbs.	

TB200/TB400/TB600

Hydraulic Pedestrian Gate Closer

- Quiet Operation
- Hydraulic/Nitrogen Gas Controlled Closing Speed
- Available Black or Stainless Steel
- Maximum Opening Angle of 100°

- For Use on Square Profile Gates
- TB Linx Kit Available for Chain Link
- Gate Stop Required for Warranty

Description	Part no.	Weight ea.	Price
-------------	----------	------------	-------

Black

Gate 36"-52", up to 125 lbs.	TB200	6 lbs.	
Gate 40"-64", up to 175 lbs.	TB400	6 lbs.	
Gate 44"-72", up to 250 lbs.	TB600	6 lbs.	



BLACK

Stainless Steel

Gate 36"-52", up to 125 lbs.	TB200SS	6 lbs.	
Gate 40"-64", up to 175 lbs.	TB400SS	6 lbs.	
Gate 44"-72", up to 250 lbs.	TB600SS	6 lbs.	



STAINLESS STEEL

TB Linx Kits

TB Linx Kit for 2 1/2" or 3" Post	TBLINX	1 lbs.	
TB Linx Kit for 4" Post	TBLINX4	2 lbs.	

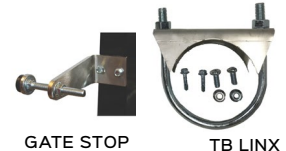

GATE STOP

TB LINX

Gate Stops

Gate Stop	GSHD90	1 lbs.	
Gate Stop-Round	GSLINX, GSLINX-4	1 lbs.	

TB250/TB450/TB650

Adjustable Hydraulic Pedestrian Gate Closer

- Quiet Operation
- Adjustable Hydraulic Controlled Closing Speed
- Available Black or Grey
- Maximum Opening Angle of 100°

- For Use on Square Profile Gates,
- TB Linx Kit Available for Chain Link
- Gate Stop Required for Warranty

Description	Part no.	Weight ea.	Price
-------------	----------	------------	-------

Black

Gate 36"-52", up to 125 lbs.	TB250B	6 lbs.	
Gate 40"-64", up to 175 lbs.	TB450B	6 lbs.	
Gate 44"-72", up to 250 lbs.	TB650B	6 lbs.	



BLACK

Grey

Gate 36"-52", up to 125 lbs.	TB250G	6 lbs.	
Gate 40"-64", up to 175 lbs.	TB450G	6 lbs.	
Gate 44"-72", up to 250 lbs.	TB650G	6 lbs.	



GREY

TB Linx Kits

TB Linx Kit for 2 1/2" or 3" Post	TBLINX	1 lbs.	
TB Linx Kit for 4" Post	TBLINX4	2 lbs.	

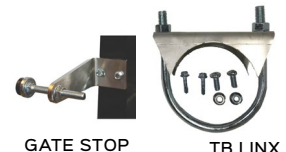

GATE STOP

TB LINX

Gate Stops

Gate Stop	GSHD90	1 lbs.	
Gate Stop-Round	GSLINX, GSLINX-4	1 lbs.	

TB950 Magnum Gate Closer

- Closing and Latching Speed Adjustments
- Concealed, High Use Pedestrian Closer
- Left or Right Hand Gates
- No Hold Open
- Electro-Galvanized Steel Finish

- Maximum Gate Width 48"
- Maximum Gate Weight 250 lbs.
- Maximum Opening Angle of 90°
- 180° Capable (Saloon Style) with 180 Drive Plate



Description	Part no.	Weight ea.	Price
-------------	----------	------------	-------

TB950 Magnum	TB950		
TB Linx Kit for 3" only	TB950LINX		
180 Drive Plate	TB950DP		

Panic Bars



EMERGENCY EXIT ONLY

6000 Surface Mount Economy Exit Bar

- Reversible
 - Dead Latch
 - Hex Key Dogging Device
 - Stainless Steel Latch Mechanism
 - Painted Aluminum Finish
 - 42" Long
- Recommended for lighter duty, interior use applications.*



- ANSI/BHMA 156.3
- Grade 1
- UL Listed

Description	Part no.	Weight ea.	Price
Surface Mount Exit Bar	6000	10 lbs.	

6003/6004 Detex® Value Series® Exit Bar

- Reversible
- Dead Latch
- Weather Resistant
- Hex Key Dogging Device
- Stainless Steel Latch Mechanism
- Anodized Aluminum Bar with Black ABS Cover on Head and Push Pad
- 36" OR 48" Long

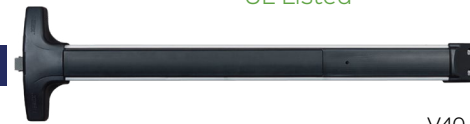

- ANSI/BHMA 156.3
- Grade 1
- UL Listed

Description	Part no.	Weight ea.	Price
Detex 36" Exit Bar	6003	14 lbs.	
Detex 48" Exit Bar	6004	16 lbs.	

V40

10003/10004 Detex® Advantex® Series Stainless Steel Exit Bar

- Tough and Durable Design for Years of Trouble-Free Service in High-Use, High-Abuse Applications
- Reversible
- Dead Latch
- Weatherized
- Hex Key Dogging Device
- Stainless Steel Latch Mechanism and Fasteners
- PVD Coating over All Exposed Surfaces
- 36" OR 48" Long

- ANSI/BHMA 156.3
- Grade 1
- UL Listed



40 x W

Description	Part no.	Weight ea.	Price
36" Detex Advantex Exit Bar	10003	18 lbs.	
48" Detex Advantex Exit Bar	10004	23 lbs.	

Electrical Options available with Advantex® Series

6930/6940 Securitron® Electromechanical Bar

- Reversible
- Weatherproof Switches
- All Metal Construction
- Black Finish
- 36" OR 48" Long
- Low Profile Design Requires Only 1/4" Movement for Activation
- Designed for Use on Magnetically Locked Gates or as an Initiating Device for Delayed Egress Timer
- Conductor Cable and Armored Door Cord Included
- 12 or 24v DC

- ANSI/UL294 listed



WEMB

Description	Part no.	Weight ea.	Price
36" WEMB	6930	7 lbs.	
48" WEMB	6940	9 lbs.	

6005 Detex® Value Series® Exit Bar with Switch

- Reversible
- Dead Latch
- Weatherized
- Less Dogging
- Stainless Steel Latch Mechanism
- Anodized Aluminum Bar with Black ABS Cover on Head and Push Pad
- 36" OR 48" Long
- Always Use in Conjunction with Other Security Items
- Provides a Normally Closed or Normally Open Contact That Can Be Used to Signal an Alarm, Remote Strobe Light or Turn a Magnetic Lock During Egress.

- ANSI/BHMA 156.3
- Grade 1
- UL Listed

Advantex® Series Device with Switch Available using 10005-36 or 10005-48

Description	Part no.	Weight ea.	Price
Detex 36" Exit Bar w/ Switch	6005-36	14 lbs.	
Detex 48" Exit Bar w/ Switch	6005-48	16 lbs.	

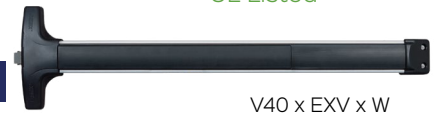

V40 x EXV x W

6006/6008 Detex® Value Series® Exit Bar with Alarm

- Reversible
- Dead Latch
- Weatherized
- Cylinder Dogging, Cylinder Provided
- Stainless Steel Latch Mechanism
- Anodized Aluminum Bar with Black ABS Cover on Head, Red Push Pad
- 36" OR 48" Long
- 100 dB Alarm
- Powered By a 9 Volt Battery
- Low Battery Alert
- Remote Bypass and Remote Signaling Capabilities

- ANSI/BHMA 156.3
- Grade 1
- UL Listed

Advantex® Series Alarm Device Available using 10006 or 10008

Description	Part no.	Weight ea.	Price
Detex 36" Exit Bar w/ Alarm	6006	15 lbs.	
Detex 48" Exit Bar w/ Alarm	6008	18 lbs.	



V40 x EB x W

6007 Detex® Value Series® Exit Bar with Electric Latch Retraction

- Reversible
- Dead Latch
- Weatherized
- No Manual Dogging
- Stainless Steel Latch Mechanism
- Anodized Aluminum Bar with Black ABS Cover on Head and Push Pad
- 36" OR 48" Long
- Use for Remote Unlocking, Remote Dogging, Access Control
- Works with Any Type of Access Control System
- Simultaneous Latch and Push Pad Retraction
- 24v DC Voltage
- Requires Logic Controller and Power Supply, Sold Separately (Page 35).

- ANSI/BHMA 156.3
- Grade 1
- UL Listed

Advantex® Series Device with Electric Latch Retraction Available using 10007-36 or 10007-48

Description	Part no.	Weight ea.	Price
Detex 36" ER Exit Bar	6007-36	17 lbs.	
Detex 48" ER Exit Bar	6007-48	19 lbs.	



V40 x ER x EX x W

ANSI 156.3 requires device to open with a force of 15 lbs. or less.

Power Supply, Flex Conduit, Maglock & Accessories Available Page 35

To order call 616.235.0140
Email: info@dacindustries.com

All DAC Mounting Plates:

- Adjustable for Gates 29" to 52" Wide (31" Minimum with Lock Box)
 - 16 Gauge Galvannealed Steel
 - Silver or Black Powder Coat Finish
- Stainless Steel Mounting Screws Included
- Fit Square or Round Gate Frames

■ Undrilled Adjustable Mounting Plates

- Blank Plate for Use with All DAC Panic Bars without Lock Box
- Can be Used with Other Manufacturer Panic Bars with or without Entry. To be Drilled Based on Bar/Trim Template Provided by Device Manufacturer.

Description	Part no.	Weight ea.	Price
24" Basic - Silver	6500-S	26 lbs.	
24" Basic - Black	6500-B	26 lbs.	



■ Drilled Adjustable Mounting Plates

- Pre-Drilled for DAC Panic Bars with Lock Box
- 24" Ultra - For Use with 6000 Bar AND Lock Box
- 24" Detex® - For Use with Detex® V40 & 40 Series Bars AND Lock Box
- 24" Universal - Can be Used with All DAC Panic Bars with Lock Box

Description	Part no.	Weight ea.	Price
24" Ultra - Silver	6600-S	26 lbs.	
24" Ultra - Black	6600-B	26 lbs.	
24" Detex - Silver	6700-S	26 lbs.	
24" Detex - Black	6700-B	26 lbs.	
24" Universal - Silver	6760-S	26 lbs.	
24" Universal - Black	6760-B	26 lbs.	



■ 6800 Extension Plates

- Additional, Undrilled Panel to Allow Mounting Plate to Expand Up to 74" Wide

Description	Part no.	Weight ea.	Price
24" Extension Plate - Silver	6800-S	13 lbs.	
24" Extension Plate - Black	6800-B	13 lbs.	



■ 12" Tall Mounting Plates

- **6900-UN**
 - Blank Plate for Use with All DAC Panic Bars without Lock Box
 - Can be Used with Other Manufacturer Panic Bars with or without Entry. To be Drilled Based on Bar/Trim Template Provided by Device Manufacturer.

6900

- Universal Drill Pattern for Use with All DAC Panic Bars with Lock Box

6800-12

- Additional, Undrilled 12" Tall Panel to Allow Mounting Plate to Extend Up to 74" Wide

Description	Part no.	Weight ea.	Price
12" Basic - Silver	6900-S-UN	13 lbs.	
12" Basic - Black	6900-B-UN	13 lbs.	
12" Universal - Silver	6900-S	13 lbs.	
12" Universal - Black	6900-B	13 lbs.	
12" Extension Plate - Silver	6800-S12	7 lbs.	
12" Extension Plate - Black	6800-B12	7 lbs.	

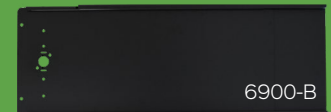

Lock Boxes

- Silver or Black Powder Coat Finish
 - Key Cylinders and Trim for Lock Boxes Sold Separately
 - 2" Lock Box for Use with Rim Cylinder
 - Lock Box with Pull Can be Used in Place of 2" Box. Offers Integrated Pull.
 - 9" Lock Box for Use with 6100, 6110, 6120, 16100, 16110, 6200 Lever Trim
 - 10" Wide Style Lock Box for Use with Wide Lever Trim
- Blank, Weldable Lock Boxes Available for Other Size Pulls and Lever Trim*



Description	Part no.	Weight ea.	Price
2" Lock Box - Silver	6025-S	.5 lb.	
2" Lock Box - Black	6025-B	.5 lb.	
2" Lock Box - NO TABS - Silver	6026-S	.5 lb.	
2" Lock Box - NO TABS - Black	6026-B	.5 lb.	
2" Lock Box w/Pull - Silver	6024-S	1 lb.	
2" Lock Box w/Pull - Black	6024-B	1 lb.	
9" Lock Box - Silver	6027-S	1 lb.	
9" Lock Box - Black	6027-B	1 lb.	
10" Wide Style Lock Box - Silver	6027WS-S	1 lb.	
10" Wide Style Lock Box - Black	6027WS-B	1 lb.	

Key Cylinders

- Solid Cast Brass
- 5-Pin Schlage C Keyway with 2 Keys
- Keyed Alike Cylinders Allow Use of Same Key for Multiple Gates
- Rim Cylinder with Extended Tailpiece Available for PVC Frames up to 4 1/2". Does not Use DAC Lock Box.

Description	Part no.	Weight ea.	Price
Keyed Alike Cylinder - Rim	6010	.5 lb.	
Keyed Alike Cylinder - Mortise	6013	.5 lb.	
Keyed Different Cylinder - Rim	6014	.5 lb.	
Cylinder w/ Ext. Tailpiece - Rim	6010-EE-Long	.5 lb.	

Lock Box Without Tabs
Allows Outside Keyed Access to be Added to Existing, Undrilled Back Plates. Requires Holes to be Drilled to Install.



RIM Housing for Interchangeable Core

- For Customers Wishing to Match Existing Lock Sets at Their Facilities
- Core & Keys to be Provided by End user
- Small Format Interchangeable Core (SFIC) Universally Sized Among Lock Manufacturers. Works with 6 or 7 Pin Core
- Large Format/Full Size Interchangeable Core (LFIC/FSIC) Size and Shape of Core Vary Among Lock Manufactures. Must Specify Brand and Number of Pins.

Description	Part no.	Weight ea.	Price
SFIC Rim Housing	6011	.5 lb.	
FSIC Rim Housing - Schlage	6011-Schlage	.5 lb.	
LFIC Rim Housing - Corbin Russwin	6011-CR 6/7	.5 lb.	
LFIC Rim Housing - Sargent	6011-Sargent	.5 lb.	



SFIC



LFIC/FSIC

MORTISE Housing for Interchangeable Core

- For Customers Wishing to Match Existing Lock Sets at Their Facilities
- Core & Keys to be Provided by End user
- Small Format Interchangeable Core (SFIC) Universally Sized Among Lock Manufacturers. Works with 6 or 7 Pin Core
- Large Format/Full Size Interchangeable Core (LFIC/FSIC) Size and Shape of Core Vary Among Lock Manufactures. Must Specify Brand and Number of Pins.

Description	Part no.	Weight ea.	Price
SFIC Mortise Housing	6012	.5 lb.	
FSIC Mortise Housing - Schlage	6012-Schlage	.5 lb.	
LFIC Mortise Housing - Corbin Russwin	6012-CR 6/7	.5 lb.	
LFIC Mortise Housing - Sargent	6012-Sargent	.5 lb.	



Panic Gate Accessories

6020 Strike Latch Receiver Bracket

- 1/4" Steel
- 1" Gap Recommended, Adjustable for 5/8" to 2" Gap (When Using Standard 3" Post)
- Stainless Steel U-bolt, Nuts, and Tek-Screws Included
- Available for 2", 2 1/2", 3" or 4" Round or Square Latch Post – Please Specify
- Silver or Black Powder Coat Finish
- Strike Sold Separately (Included with Bars/Kits)



Description	Part no.	Weight ea.	Price
Receiver - Silver	6020-S	2.5 lbs.	
Receiver - Black	6020-B	2.75 lbs.	

Strike

- Replacement Strikes
- All Bars and Kits Come with Strikes

Description	Part no.	Weight ea.	Price
Strike for 6000 Bar	STRIKE ULT	.2 lbs.	
Strike for Detex Bar	STRIKE DTX	.2 lbs.	



Replacement Components

Description	Part no.	Weight ea.	Price
Hardware Bag for Silver 6030/6040 Kits	PB BAG ULTRA-S	.5 lbs.	
Hardware Bag for Black 6030/6040 Kits	PB BAG ULTRA-B	.5 lbs.	
Hardware Bag for Silver Detex Kits	PB BAG DETEX-S	.5 lbs.	
Hardware Bag for Black Detex Kits	PB BAG DETEX-B	.5 lbs.	
Pushpad Wrap - Black, No Writing 3' Bar	PUSHPAD BLACK 3'	.5 lbs.	
Pushpad Wrap - Black, No Writing 4' Bar	PUSHPAD BLACK 4'	.5 lbs.	
Pushpad Wrap - Red, "Alarm Will Sound" 3' Bar	PUSHPAD ALARM 3'	.5 lbs.	
Pushpad Wrap - Red, "Alarm Will Sound" 4' Bar	PUSHPAD ALARM 4'	.5 lbs.	
End Cap for Detex® Value Series®	ENDCAP	.5 lbs.	
Centercase/Head Cover for Detex® Value Series®	HEADCOVER	.5 lbs.	

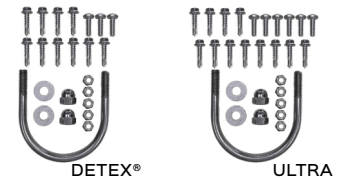

DAC Gate Accessories



Detex® Exit Device

Replacement Components

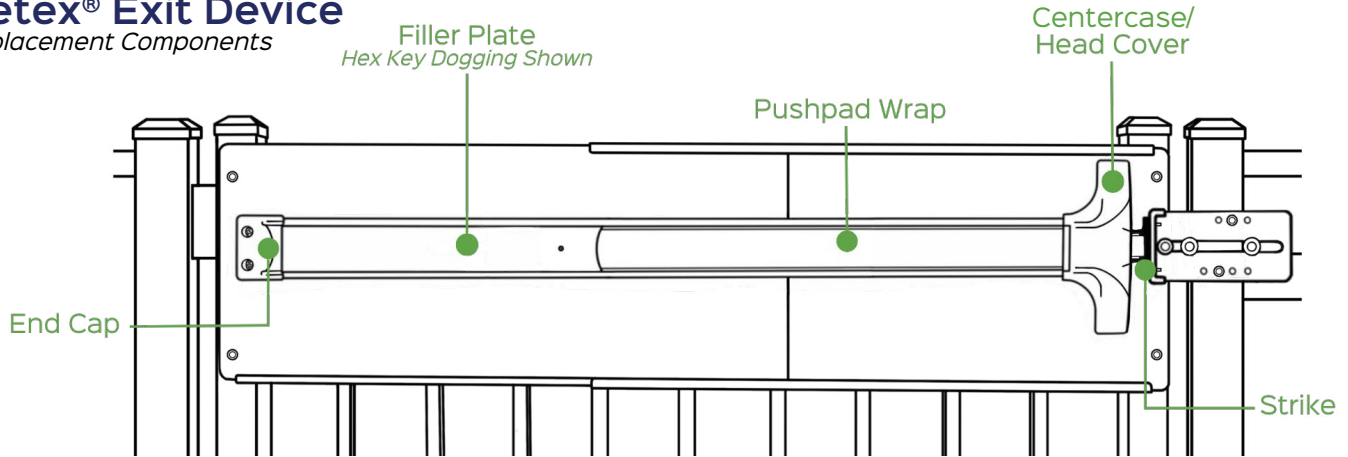

6015 Gate Latch Protector - For 12" Plates

- Provides Added Security Against Reaching Between the Gate and Latch Post
- Use on Existing Gates Where Gap is Larger Than 1"
- Mounts to Gate Frame
- 12" Tall
- For 3" Post
- Silver or Black Powder Coat Finish



Description	Part no.	Weight ea.	Price
Gate Latch Protector - Silver	6015-S-12	1.65 lbs.	
Gate Latch Protector - Black	6015-B-12	1.65 lbs.	

6015 Gate Latch Protector - For 24" Plates

- Provides Added Security Against Reaching Between the Gate and Latch Post
- Use on Existing Gates Where Gap is Larger Than 1"
- Available for 2", 3" or 4" Round or Square Latch Post. **3" Standard.**
- Mounts to Gate Frame
- 24" Tall
- Silver or Black Powder Coat Finish



Description	Part no.	Weight ea.	Price
Gate Latch Protector - Silver	6015-S	3.5 lbs.	
Gate Latch Protector - Black	6015-B	3.5 lbs.	
Gate Latch Protector - Silver - 2" Post	6015-S-2	3.5 lbs.	
Gate Latch Protector - Black - 2" Post	6015-B-2	3.5 lbs.	
Gate Latch Protector - Silver - 4" Post	6015-S-4	3.5 lbs.	
Gate Latch Protector - Black - 4" Post	6015-B-4	3.5 lbs.	

6016 Half Moon Protector

- Provides Added Protection from Outside Tampering
- Mounts to Hinge or Latch Post Using Brace Bands (Not Included)
- 24" Tall and 12" at Widest Point
- Silver or Black Powder Coat Finish

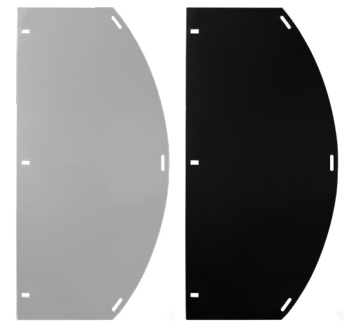

Description	Part no.	Weight ea.	Price
Half Moon Protector - Silver	6016-S	4 lbs.	
Half Moon Protector - Black	6016-B	4 lbs.	

6017 Push Pad Protector

- Protects Panic Bar from Being Depressed with Rope or Wire from the Outside
- 26" Wide
- Silver, Black or Red Powder Coat Finish

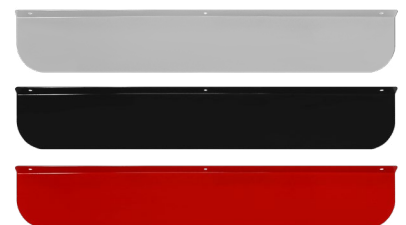

Description	Part no.	Weight ea.	Price
Push Pad Protector - Silver	6017-S	2 lbs.	
Push Pad Protector - Black	6017-B	2 lbs.	
Push Pad Protector - Red	6017-R	2 lbs.	

Exit Only Panic Kits

6030 Standard Kit - No Lock Box

- Surface Mount Economy Exit Bar #6000
 - 24" Mounting Plate, Adjusts for 29" to 52" Gate Frame
 - Adjustable Receiver Bracket for 3" O.D. Latch Post*
 - Stainless Steel Tek-Screws and Fasteners Included
- ALLOWS FOR EXIT ONLY. Requires holes to be drilled for exit bar.*

Description	Part no.	Weight ea.	Price
Standard Kit - Silver	6030-S	38 lbs.	
Standard Kit - Black	6030-B	38 lbs.	



6035 Standard Kit - No Lock Box - Detex® Exit Bar

- Detex® Value Series® Exit Bar
 - 24" Mounting Plate, Adjusts for 29" to 52" Gate Frame
 - Adjustable Receiver Bracket for 3" O.D. Latch Post*
 - Stainless Steel Tek-Screws and Fasteners Included
- ALLOWS FOR EXIT ONLY. Requires holes to be drilled for exit bar.*

Description	Part no.	Weight ea.	Price
Standard Kit 36" Bar - Silver Plate	6035-S36	43 lbs.	
Standard Kit 48" Bar - Silver Plate	6035-S48	45 lbs.	
Standard Kit 36" Bar - Black Plate	6035-B36	43 lbs.	
Standard Kit 48" Bar - Black Plate	6035-B48	45 lbs.	



Description - Includes #6005 Bar w. Switch

Standard Kit w/switch 36" Bar - Silver Plate	6035-S36-EXV	43 lbs.	
Standard Kit w/switch 48" Bar - Silver Plate	6035-S48-EXV	45 lbs.	
Standard Kit w/switch 36" Bar - Black Plate	6035-B36-EXV	43 lbs.	
Standard Kit w/switch 48" Bar - Black Plate	6035-B48-EXV	45 lbs.	

Description - Includes #6007 Bar w. Electric Latch Retraction

Standard Kit w/ER 36" Bar - Silver Plate	6035-S36-ER	43 lbs.	
Standard Kit w/ER 48" Bar - Silver Plate	6035-S48-ER	45 lbs.	
Standard Kit w/ER 36" Bar - Black Plate	6035-B36-ER	43 lbs.	
Standard Kit w/ER 48" Bar - Black Plate	6035-B48-ER	45 lbs.	

6037 Standard Kit - No Lock Box - Detex® Exit Bar with Alarm

- #6006 or #6008 Detex® Value Series® Weatherized Alarmed Exit Bar
 - 24" Mounting Plate, Adjusts for 29" to 52" Gate Frame
 - Adjustable Receiver Bracket for 3" O.D. Latch Post*
 - Stainless Steel Tek-Screws and Fasteners Included
- ALLOWS FOR EXIT ONLY. Requires holes to be drilled for exit bar.*

Description	Part no.	Weight ea.	Price
Standard Kit w/alarm 36" Bar - Silver Plate	6037-S36	43 lbs.	
Standard Kit w/alarm 48" Bar - Silver Plate	6037-S48	45 lbs.	
Standard Kit w/alarm 36" Bar - Black Plate	6037-B36	43 lbs.	
Standard Kit w/alarm 48" Bar - Black Plate	6037-B48	45 lbs.	



*2", 2 1/2", 4" Round or Square U-Bolts Available Upon Request

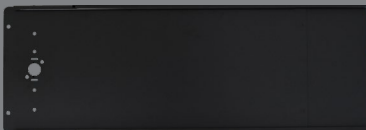

All kits available with a 12" tall mounting plate upon request.

10035 Standard Kit - No Lock Box - Detex® Advantex® Exit Bar

- Detex® Advantex® Series Weatherized Stainless Steel Exit Bar
 - 24" Mounting Plate, Adjusts for 29" to 52" Gate Frame
 - Adjustable Receiver Bracket for 3" O.D. Latch Post*
 - Stainless Steel Tek-Screws and Fasteners Included
- ALLOWS FOR EXIT ONLY. Requires holes to be drilled for exit bar.*

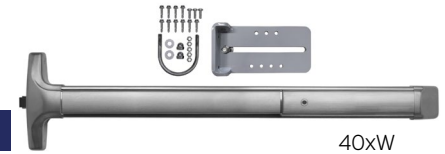

Description	Part no.	Weight ea.	Price
-------------	----------	------------	-------

Standard Kit w/Advantex 36" Bar - Silver Plate	10035-S36	44 lbs.	
Standard Kit w/Advantex 48" Bar - Silver Plate	10035-S48	49 lbs.	
Standard Kit w/Advantex 36" Bar - Black Plate	10035-B36	44 lbs.	
Standard Kit w/Advantex 48" Bar - Black Plate	10035-B48	49 lbs.	

Description - Includes #10005 Bar w. Switch

Standard Kit Adv w/switch 36" Bar - Silver Plate	10035-S36-EXV	44 lbs.	
Standard Kit Adv w/switch 48" Bar - Silver Plate	10035-S48-EXV	49 lbs.	
Standard Kit Adv w/switch 36" Bar - Black Plate	10035-B36-EXV	44 lbs.	
Standard Kit Adv w/switch 48" Bar - Black Plate	10035-B48-EXV	49 lbs.	

Description - Includes 10007 Bar w. Electric Latch Retraction

Standard Kit Adv w/ER 36" Bar - Silver Plate	10035-S36-ER	44 lbs.	
Standard Kit Adv w/ER 48" Bar - Silver Plate	10035-S48-ER	49 lbs.	
Standard Kit Adv w/ER 36" Bar - Black Plate	10035-B36-ER	44 lbs.	
Standard Kit Adv w/ER 48" Bar - Black Plate	10035-B48-ER	49 lbs.	



10037 Standard Kit - No Lock Box - Detex® Advantex® Exit Bar with Alarm

- #10006 or #10008 Detex® Advantex® Series Weatherized Alarmed Stainless Steel Exit Bar
 - 24" Mounting Plate, Adjusts for 29" to 52" Gate Frame
 - Adjustable Receiver Bracket for 3" O.D. Latch Post*
 - Stainless Steel Tek-Screws and Fasteners Included
- ALLOWS FOR EXIT ONLY. Requires holes to be drilled for exit bar.*

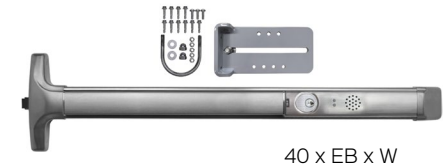

Description	Part no.	Weight ea.	Price
-------------	----------	------------	-------

Standard Kit Adv w/alarm 36" Bar - Silver Plate	10037-S36	44 lbs.	
Standard Kit Adv w/alarm 48" Bar - Silver Plate	10037-S48	49 lbs.	
Standard Kit Adv w/alarm 36" Bar - Black Plate	10037-B36	44 lbs.	
Standard Kit Adv w/alarm 48" Bar - Black Plate	10037-B48	49 lbs.	



10035-B36-12

Panic Kits with Re-Entry

6040 Deluxe Exit Bar Kit

- Surface Mount Economy Exit Bar #6000
- 24" Mounting Plate, Adjusts for 31" to 52" Gate Frame
- Adjustable Receiver Bracket for 3" O.D. Latch Post*
- Lock Box - Allows for Entry from Outside of Gate
- Key Cylinder with 2 Keys
- Pre-Drilled Holes for Exit Bar and Lock Box
- Stainless Steel Tek-Screws and Fasteners Included



Description	Part no.	Weight ea.	Price
Deluxe Kit - Silver	6040-S	38 lbs.	
Deluxe Kit - Black	6040-B	38 lbs.	

6045 Superior Kit - Detex® Exit Bar

- Detex® Value Series® Exit Bar
- 24" Mounting Plate, Adjusts for 31" to 52" Gate Frame
- Adjustable Receiver Bracket for 3" O.D. Latch Post*
- Lock Box - Allows for Entry from Outside of Gate
- Key Cylinder with 2 Keys
- Pre-Drilled Holes for Exit Bar and Lock Box
- Stainless Steel Tek-Screws and Fasteners Included



Description	Part no.	Weight ea.	Price
Superior Kit 36" Bar - Silver Plate	6045-S36	43 lbs.	
Superior Kit 48" Bar - Silver Plate	6045-S48	45 lbs.	
Superior Kit 36" Bar - Black Plate	6045-B36	43 lbs.	
Superior Kit 48" Bar - Black Plate	6045-B48	45 lbs.	

Description - Includes Bar w. Switch

Superior Kit w/switch 36" Bar - Silver Plate	6045-S36-EXV	43 lbs.	
Superior Kit w/switch 48" Bar - Silver Plate	6045-S48-EXV	45 lbs.	
Superior Kit w/switch 36" Bar - Black Plate	6045-B36-EXV	43 lbs.	
Superior Kit w/switch 48" Bar - Black Plate	6045-B48-EXV	45 lbs.	

Description - Includes Bar w. Electric Latch Retraction

Superior Kit w/ER 36" Bar - Silver Plate	6045-S36-ER	43 lbs.	
Superior Kit w/ER 48" Bar - Silver Plate	6045-S48-ER	45 lbs.	
Superior Kit w/ER 36" Bar - Black Plate	6045-B36-ER	43 lbs.	
Superior Kit w/ER 48" Bar - Black Plate	6045-B48-ER	45 lbs.	

6047 Superior Kit - Detex® Exit Bar with Alarm

- #6006 or #6008 Detex® Value Series® Alarmed Exit Bar
- 24" Mounting Plate, Adjusts for 31" to 52" Gate Frame
- Adjustable Receiver Bracket for 3" O.D. Latch Post*
- Lock Box - Allows for Entry from Outside of Gate
- Key Cylinder with 2 Keys
- Pre-Drilled Holes for Exit Bar and Lock Box
- Stainless Steel Tek-Screws and Fasteners Included



Description	Part no.	Weight ea.	Price
Superior Kit w/alarm 36" Bar - Silver Plate	6047-S36	43 lbs.	
Superior Kit w/alarm 48" Bar - Silver Plate	6047-S48	45 lbs.	
Superior Kit w/alarm 36" Bar - Black Plate	6047-B36	43 lbs.	
Superior Kit w/alarm 48" Bar - Black Plate	6047-B48	45 lbs.	

*2", 2 1/2", 4" Round or Square U-Bolts Available Upon Request

10045 Premium Kit - Detex® Advantex® Exit Bar

- Detex® Advantex® Series Weatherized, Stainless Steel Exit Bar
- 24" Mounting Plate, Adjusts for 31" to 52" Gate Frame
- Adjustable Receiver Bracket for 3" O.D. Latch Post*
- Lock Box - Allows for Entry from Outside of Gate
- Key Cylinder with 2 Keys
- Pre-Drilled Holes for Exit Bar and Lock Box

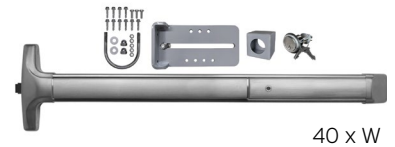

40 x W



Description	Part no.	Weight ea.	Price
-------------	----------	------------	-------

Premium Kit Advantex 36" Bar – Silver Plate	10045-S36	44 lbs.	
Premium Kit Advantex 48" Bar – Silver Plate	10045-S48	49 lbs.	
Premium Kit Advantex 36" Bar – Black Plate	10045-B36	44 lbs.	
Premium Kit Advantex 48" Bar – Black Plate	10045-B48	49 lbs.	

Description - Includes Bar w. Switch

Premium Kit Adv w/switch 36" Bar – Silver Plate	10045-S36-EXV	44 lbs.	
Premium Kit Adv w/switch 48" Bar – Silver Plate	10045-S48-EXV	49 lbs.	
Premium Kit Adv w/switch 36" Bar – Black Plate	10045-B36-EXV	44 lbs.	
Premium Kit Adv w/switch 48" Bar – Black Plate	10045-B48-EXV	49 lbs.	

Description - Includes Bar w. Electric Latch Retraction

Premium Kit Adv w/ER 36" Bar – Silver Plate	10045-S36-ER	44 lbs.	
Premium Kit Adv w/ER 48" Bar – Silver Plate	10045-S48-ER	49 lbs.	
Premium Kit Adv w/ER 36" Bar – Black Plate	10045-B36-ER	44 lbs.	
Premium Kit Adv w/ER 48" Bar – Black Plate	10045-B48-ER	49 lbs.	

10047 Premium Kit - Detex® Advantex® Exit Bar with Alarm

- #10006 or #10008 Detex® Advantex® Series Weatherized, Stainless Steel Alarmed Exit Bar
- 24" Mounting Plate, Adjusts for 31" to 52" Gate Frame
- Adjustable Receiver Bracket for 3" O.D. Latch Post*
- Lock Box - Allows for Entry from Outside of Gate
- Key Cylinder with 2 Keys
- Pre-Drilled Holes for Exit Bar and Lock Box

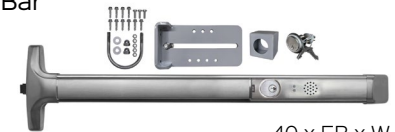

40 x EB x W



Description	Part no.	Weight ea.	Price
-------------	----------	------------	-------

Premium Kit Adv w/alarm 36" Bar – Silver Plate	10047-S36	44 lbs.	
Premium Kit Adv w/alarm 48" Bar – Silver Plate	10047-S48	49 lbs.	
Premium Kit Adv w/alarm 36" Bar – Black Plate	10047-B36	44 lbs.	
Premium Kit Adv w/alarm 48" Bar – Black Plate	10047-B48	49 lbs.	

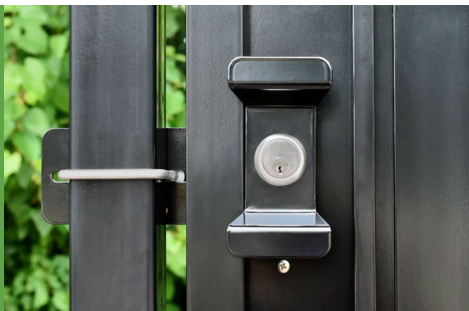

All kits with re-entry can be upgraded to lock box with pull (pg. 19).

Panic Hardware Outside Trim

DDGH D&D® Gate Handle™

- Simple and Stylish
- Polymer Construction, Strong and 100% Rust Proof
- Fits Metal, Wood, Vinyl Gates.
- 6 3/16" Tall

Description	Part no.	Weight ea.	Price
Poly Gate Handle	DDGH	.2 lbs.	

LOCGH Locinox® Gate Handle

- Fixed Anodized Aluminum Handle, Black Finish
- Available Single (1) or Double Sided (2), Straight (00) or Angled (60) Mounting
- Fits 1 1/2" - 2 1/2" Metal Gate Frames
- 14 3/8" Tall

Description	Part no.	Weight ea.	Price
Straight, Single Side	LOCGH-00-1	3 lbs.	
Straight, Double Sided	LOCGH-00-2	4 lbs.	
Angled, Single Side	LOCGH-60-1	3 lbs.	
Angled, Double Sided	LOCGH-60-2	5 lbs.	

6103AN

DETEX® 03AN Pull with Rim Cylinder & Fasteners Added

- Steel Stamping, Black or Silver Finish
- BHMA 03 - Key Retracts Latch Bolt
- Includes Rim Cylinder with 2 Keys
- 13 1/2" Tall x 1 7/8" Wide. 2 1/16" Projection

Description	Part no.	Weight ea.	Price
Silver Pull	6103AN-S	1.6 lbs.	
Black Pull	6103AN-B	1.6 lbs.	

6103PN

DETEX® 03PN Pull with Rim Cylinder & Fasteners Added

- Aluminum Stamping, Black or Silver Finish
- BHMA 03 - Key Retracts Latch Bolt
- Includes Rim Cylinder with 2 Keys
- 6 1/2" Tall x 2" Wide. 1 15/32" Pull Projection

Description	Part no.	Weight ea.	Price
Silver Pull	6103PN-S	1 lb.	
Black Pull	6103PN-B	1 lb.	

115P

LockeyUSA™ Mechanical Combination Lock for Panic Bar

- Combo Lock with Lever Handle
 - Recessed Buttons
 - Field Reversible
 - Single code, Can be Changed
 - Silver Marine Grade Finish
- SEE #6400-DAC for Use with DAC Panic Bar Kits

Description	Part no.	Weight ea.	Price
Combo Lock	115P	5 lbs.	



Pg 26 Pulls Attach to Square Profile Gate Frames and do NOT use DAC Lock Boxes or Pre-drilled Mounting Plates

Pg. 27-29 Trim Options are Add-Ons to 6045, 6047, 10045 and 10047 Kits.

6100-B
6110-B

Lock Box with Integrated Pull

- Easy to Grasp
- 1 1/2" Knuckle Clearance
- Black or Silver
- Key Retracts Latch Bolt
- Rim Cylinder and 2 Keys Included

Description	Part no.	Weight ea.	Price
Lock Box with Pull - Silver	6024-S-RC	3 lbs.	
Lock Box with Pull - Black	6024-B-RC	3 lbs.	



6100/6110 Lever Style Handle

DETEX® 08/09BN VS Trim with DAC Lock Box, Mortise Cylinder & Fasteners Added

- ADA Compliant (6100)
 - Field Reversible
 - Mortise Cylinder and 2 Keys Included
 - Cast Aluminum with Black or Silver Finish
- AVAILABLE IN:**
Classroom Function - Outside Lever is locked and unlocked by key. Can be left in locked or unlocked setting.
Storeroom Function - Outside lever always needs key to unlock.

Description	Part no.	Weight ea.	Price
Lever Handle - Classroom - Silver	6100-S	4 lbs.	
Lever Handle - Classroom - Black	6100-B	4 lbs.	
Lever Handle - Storeroom - Silver	6110-S	4 lbs.	
Lever Handle - Storeroom - Black	6110-B	4 lbs.	



6120 Always Active Lever Style Handle

DETEX® 14BN Value Series® Trim with DAC Lock Box & Fasteners Added

- ADA Compliant
- Field Reversible
- Cast Aluminum with Black or Silver Painted Finish
- Free Entry

Description	Part no.	Weight ea.	Price
Lever Handle - Always Active - Silver	6120-S	4 lbs.	
Lever Handle - Always Active - Black	6120-B	4 lbs.	



16100/16110 Lever Style Handle

DETEX® 08/09DN Advantex® Trim with DAC Lock Box, Mortise Cylinder & Fasteners Added

- ADA Compliant (16100)
 - Field Reversible
 - Mortise Cylinder and 2 Keys Included
 - Forged Brass with Brushed Chrome Finish
 - Black or Silver Lock Box
- AVAILABLE IN:**
Classroom Function - Outside lever is locked and unlocked by key. Can be left in locked or unlocked setting.
Storeroom Function - Outside lever always needs key to unlock.

Description	Part no.	Weight ea.	Price
Lever Handle - Classroom - Silver Box	16100-S	4 lbs.	
Lever Handle - Classroom - Black Box	16100-B	4 lbs.	
Lever Handle - Storeroom - Silver Box	16110-S	4 lbs.	
Lever Handle - Storeroom - Black Box	16110-B	4 lbs.	



To order call 616.235.0140
Email: info@dacindustries.com

Panic Hardware Outside Trim

6200 Electrified Control Trim*

Securitech® LEXI™ Trim with DAC Lock Box, Mortise Cylinder, Fasteners & Appropriate Spindle Added

- ADA Compliant
- Mechanical Key Override (Mortise Cylinder and 2 Keys Included)
- Electric Release Within Lever
- Handle Released by Any Access Control System or Remote Release
- Offers Fail Secure System
- Left or Right Hand Reverse – Must Specify (Not Field Reversible)
- Black Finish Standard (Stainless Steel Available), Lock Box Available in Black or Silver
- 24v DC Power Supply Needed



Description	Part no.	Weight ea.	Price
Electrified Lever - LHR - Silver Box	6200-LHR-S	6 lbs.	
Electrified Lever - LHR - Black Box	6200-LHR-B	6 lbs.	
Electrified Lever - RHR - Silver Box	6200-RHR-S	6 lbs.	
Electrified Lever - RHR - Black Box	6200-RHR-B	6 lbs.	

6250 Electrified Control Trim*

DETEX® EU2W Trim with DAC Lock Box, Mortise Cylinder, Fasteners & Appropriate Spindle Added

- ADA Compliant
- Mechanical Key Override (Mortise Cylinder and 2 Keys Included)
- Electric Release Within Lever
- Handle Released by Any Access Control System or Remote Release
- Offers Fail Secure System
- Left or Right Hand Reverse - Must Specify (Not Field Reversible)
- Brushed Chrome Finish, Lock Box Available in Black or Silver
- 24v DC Power Supply Needed



Description	Part no.	Weight ea.	Price
Electrified Lever - LHR - Silver Box	6250-LHR-S	6.5 lbs.	
Electrified Lever - LHR - Black Box	6250-LHR-B	6.5 lbs.	
Electrified Lever - RHR - Silver Box	6250-RHR-S	6.5 lbs.	
Electrified Lever - RHR - Black Box	6250-RHR-B	6.5 lbs.	

* Requires Handing to be Specified. Not Reversible.

Handing Diagram

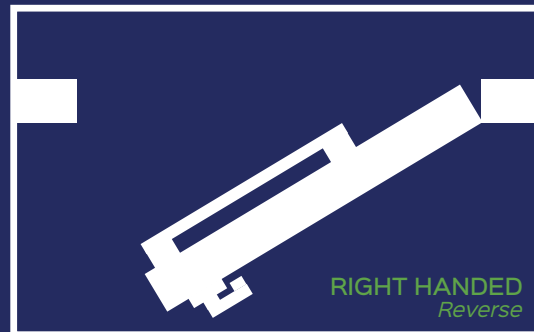

Handing is always determined by the hinge location on the exterior. As exit doors always swing outward, the handling can be LHR (hinge on left hand side) or RHR (hinge on right hand side).

**Mechanical Combination Locks use a Single, Numeric Push Button Code to Unlock.
No cards, Electronics, or Batteries are Needed.**

6300 Mechanical Combination Lock

- **KABA® Simplex® 2015 Trim with DAC Lock Box & Fasteners Added**
 - Fully Mechanical with Large, Easy to Depress Buttons
 - Thumb Turn Knob, Not Handed
 - Single Code, On Gate Code Change
 - Brushed Chrome Finish

Description	Part no.	Weight ea.	Price
Mechanical Combo Lock - Silver Box	6300-S	5lbs.	
Mechanical Combo Lock - Black Box	6300-B	5lbs.	

6400-DAC Mechanical Combination Lock*

- **LockeyUSA™ 115P Trim with DAC Lock Box, Fasteners & Appropriate Spindle Added**
 - Combo Lock with Lever Handle
 - Recessed Buttons
 - Left or Right Hand Reverse – Must Specify (Not Field Reversible)
 - Single Code, Can be Changed
 - Breakaway Slip Clutch Lever
 - Silver Marine Grade Finish

Description	Part no.	Weight ea.	Price
Mechanical Combo Lock - Left Hand - Silver Box	6400-DAC-LH-S	6 lbs.	
Mechanical Combo Lock - Left Hand - Black Box	6400-DAC-LH-B	6 lbs.	
Mechanical Combo Lock - Right Hand - Silver Box	6400-DAC-RH-S	6 lbs.	
Mechanical Combo Lock - Right Hand - Black Box	6400-DAC-RH-B	6 lbs.	

6450 Mechanical Combination Lock

- **BorgLocks™ 5708MGPro-ECP with DAC Lock Box, Fasteners & Appropriate Spindle Added**
 - Combo Lock with Lever Handle and Key Override
 - Field Reversible
 - Single Code, On Gate Code Change
 - Breakaway Slip Clutch Lever
 - Black Marine Grade Finish

Description	Part no.	Weight ea.	Price
Mechanical Combo Lock - Silver Box	6450-S	6 lbs.	
Mechanical Combo Lock - Black Box	6450-B	6 lbs.	



6350 Mechanical Combination Lock*

- **Kaba® Simplex® LP1000 Series Trim with Weld In Lock Box and Fasteners Added**
 - Combo Lock with Lever Handle and Optional Key Override
 - Left or Right Hand Reverse - Must Specify (Not Field Reversible)
 - Single Code, On Gate Code Change
 - Satin Chrome Finish
 - Steel or Aluminum Lock Box Included
 - Specify No Key Override (1010) or Key Override (1020).
 - SFIC (B) Prep Available With 1020. LFIC Options Available Upon Request. CORE & Keys NOT Included.

Description	Part no.	Weight ea.	Price
Entry by Combination Only			
Mechanical Combo Lock - LHR - Steel LLP1010 -LHR with Steel Box	6350-1010-LHR	12 lbs.	
Mechanical Combo Lock-RHR Steel LRP1010 -RHR with Steel Box	6350-1010-RHR	12 lbs.	
Mechanical Combo Lock-LHR AL LLP1010 -LHR with Aluminum Box	6350-1010-LHR-AL	12 lbs.	
Mechanical Combo Lock-RHR AL LRP1010 -RHR with Aluminum Box	6350-1010-RHR-AL	12 lbs.	
Entry by Combination or Key			
Mechanical Combo Lock - LHR - Steel LLP1020 B-LHR with Steel Box	6350-1020-LHR	12 lbs.	
Mechanical Combo Lock-RHR Steel LRP1020 B-RHR with Steel Box	6350-1020-RHR	12 lbs.	
Mechanical Combo Lock-LHR AL LLP1020 B-LHR with Aluminum Box	6350-1020-LHR-AL	12 lbs.	
Mechanical Combo Lock-RHR AL LRP1020 B-RHR with Aluminum Box	6350-1020-RHR-AL	12 lbs.	

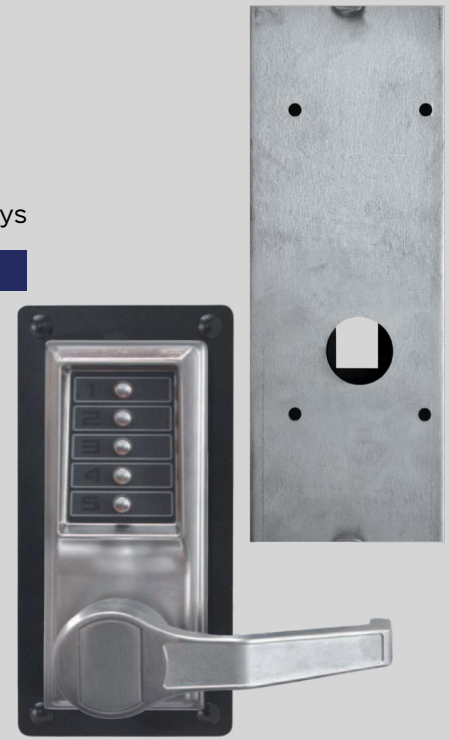

To order call 616.235.0140
Email: info@dacindustries.com

Standalone Lever Lock Kits

LockeyUSA™ 2835 Combo Lock/Lever Handle Kit

- Available with Single or Dual Sided Combination
- Passage Feature (Ability to Leave Unlocked)
- Field Reversible
- Single Code, Can be Changed
- Silver Marine Grade Finish
- Includes Weldable Steel OR Aluminum Lock Box GB2500 (4 3/4" W x 7 5/8" H x 1 3/4" D)
- Includes Silver or Black Adjustable Receiver with Gate Stop



Description	Part no.	Weight ea.	Price
Single Sided			
2835 Kit Steel Box, Silver Reciever	2835Kit-S	9 lbs.	
2835 Kit Steel Box, Black Reciever	2835Kit-B	9 lbs.	
2835 Kit Aluminum Box, Silver Reciever	2835Kit-AL-S	8 lbs.	
2835 Kit Aluminum Box, Black Reciever	2835Kit-AL-B	8 lbs.	
Dual Sided			
2835 DC Kit Steel Box, Silver Reciever	2835Kit-DC-S	10 lbs.	
2835 DC Kit Steel Box, Black Reciever	2835Kit-DC-B	10 lbs.	
2835 DC Kit Aluminum Box, Silver Reciever	2835Kit-DC-AL-S	9 lbs.	
2835 DC Kit Aluminum Box, Black Reciever	2835Kit-DC-AL-B	9 lbs.	

LockeyUSA™ 1150 Heavy Duty Combo Lock/Lever Handle Kit

- Available with Single or Dual Sided Combination
- Passage Feature (Ability to Leave Unlocked)
- Field Reversible
- Single Code, Can be Changed
- Silver Marine Grade Finish
- Recessed Buttons
- Breakaway Slip Clutch Lever
- Includes Weldable Steel OR Aluminum Lock Box GB1150 (4 3/4" W x 7 5/8" H x 1 3/4" D)
- Includes Silver or Black Adjustable Receiver with Gate Stop



Description	Part no.	Weight ea.	Price
Single Sided			
1150 Kit Steel Box, Silver Reciever	1150Kit-S	12 lbs.	
1150 Kit Steel Box, Black Reciever	1150Kit-B	12 lbs.	
1150 Kit Aluminum Box, Silver Reciever	1150Kit-AL-S	10 lbs.	
1150 Kit Aluminum Box, Black Reciever	1150Kit-AL-B	10 lbs.	
Dual Sided			
1150 DC Kit Steel Box, Silver Reciever	1150Kit-DC-S	13 lbs.	
1150 DC Kit Steel Box, Black Reciever	1150Kit-DC-B	13 lbs.	
1150 DC Kit Aluminum Box, Silver Reciever	1150Kit-DC-AL-S	12 lbs.	
1150 DC Kit Aluminum Box, Black Reciever	1150Kit-DC-AL-B	12 lbs.	

BorgLocks™ BL5700 Series Combo Lock/Lever Kit

- Available with Single (BL5701) or Dual (BL5771) Sided Combination
- Passage Feature (Ability to Leave Unlocked)
- Field Reversible
- Single Access Code, Combo Changed without Removing Lock from Gate
- Black Marine Grade Finish
- Breakaway Slip Clutch Lever
- Key Override
- Includes Weldable Steel OR Aluminum Lock Box (5 1/2" W x 8 1/2" H x 1 3/4" D)
- Includes Silver or Black Adjustable Receiver with Gate Stop



Description	Part no.	Weight ea.	Price
Single Sided			
BL5701 Kit Steel Box, Silver Reciever	BL5701Kit-S	13 lbs.	
BL5701 Kit Steel Box, Black Reciever	BL5701Kit-B	13 lbs.	
BL5701 Kit Aluminum Box, Silver Reciever	BL5701Kit-AL-S	11 lbs.	
BL5701 Kit Aluminum Box, Black Reciever	BL5701Kit-AL-B	11 lbs.	
Dual Sided			
BL5771 DC Kit Steel Box, Silver Reciever	BL5771Kit-DC-S	15 lbs.	
BL5771 DC Kit Steel Box, Black Reciever	BL5771Kit-DC-B	15 lbs.	
BL5771 DC Kit Aluminum Box, Silver Reciever	BL5771Kit-DC-AL-S	13 lbs.	
BL5771 DC Kit Aluminum Box, Black Reciever	BL5771Kit-DC-AL-B	13 lbs.	

Kaba® L1000 Series Simplex® Combo Lock/Lever Handle Kit

- Vandal Resistant, Solid Metal Pushbuttons
- Single Access Code
- Satin Chrome Finish
- Combination Changed without Removing Lock from Gate
- Factory-Handed; Not Field Reversible (Handing Diagram on Page 28)
- No Key Override (1011), Key Override (1021), or Key Override Plus Passage (1041) Available
- Includes Weldable Steel OR Aluminum Lock Box K-BXSIM (5 1/2" W X 8 1/2" H X 1 3/4" D)
- Includes Silver or Black Adjustable Receiver with Gate Stop



Description	Part no.	Weight ea.	Price
No Key Override			
Steel Box, Silver Receiver	L*101Kit-S	17 lbs.	
Steel Box, Black Receiver	L*101Kit-B	17 lbs.	
Aluminum Box, Silver Receiver	L*101Kit-AL-S	15 lbs.	
Aluminum Box, Black Receiver	L*101Kit-AL-B	15 lbs.	
Key Override/Best Prep			
Steel Box, Silver Receiver	L*102Kit-S	17 lbs.	
Steel Box, Black Receiver	L*102Kit-B	17 lbs.	
Aluminum Box, Silver Receiver	L*102Kit-AL-S	15 lbs.	
Aluminum Box, Black Receiver	L*102Kit-AL-B	15 lbs.	
Key Override/Best Prep + Passage			
Steel Box, Silver Receiver	L*104Kit-S	17 lbs.	
Steel Box, Black Receiver	L*104Kit-B	17 lbs.	
Aluminum Box, Silver Receiver	L*104Kit-AL-S	15 lbs.	
Aluminum Box, Black Receiver	L*104Kit-AL-B	15 lbs.	

*- Specify Handing

Arrow™ MLX Series Cylindrical Lever Lock Kit

- Strong and Durable, ANSI/BHMA Grade 2 Certified
- Available in Storeroom or Classroom Function
- Satin Chrome Finish
- Freewheeling Feature for Abuse Resistance
- Schlage CS Keyway, IC Prep Available
- ADA Compliant Lever Style
- Includes Weldable Steel OR Aluminum Lock Box (4 3/4" W x 7 5/8" H x 1 3/4" D)
- Includes Silver or Black Adjustable Receiver with Gate Stop



Description	Part no.	Weight ea.	Price
Classroom Function			
Steel Box, Silver Receiver	MLX87Kit-S	9 lbs.	
Steel Box, Black Receiver	MLX87Kit-B	9 lbs.	
Aluminum Box, Silver Receiver	MLX87Kit-AL-S	9 lbs.	
Aluminum Box, Black Receiver	MLX87Kit-AL-B	9 lbs.	
Storeroom Function			
Steel Box, Silver Receiver	MLX82Kit-S	9 lbs.	
Steel Box, Black Receiver	MLX82Kit-B	9 lbs.	
Aluminum Box, Silver Receiver	MLX82Kit-AL-S	9 lbs.	
Aluminum Box, Black Receiver	MLX82Kit-AL-B	9 lbs.	

Ask About Our

Schlage ND Series options
for Heavy Duty Installations

6022 Gate Lock Adjustable Receiver

- Included in DAC Gate Lock Kits. Can be Purchased Individually.
- Allows for Easy, Adjustable Installation
- Includes Gate Stop
- Allows for 1 5/8" Min to 3" Max Latch Gap (When Using Standard 3" Post)
- Stainless Steel U-Bolt, Nuts, and Tek-Screws Included
- Fits Round or Square Post
- Silver or Black Powder Coat Finish



Standalone Lever Lock Kits

◆ Locinox® LUKY KIT

Gate Lock with Security Gate Keep/Stop

- Two-Sided Keyed Access
- Pair of Schlage C Keyway Mortise Cylinders Included
- Left or Right Handed Gates
- Key-Operated Self-Latching Bolt + Deadbolt
- Alternate Functions Available with Purchase of Blocking Knob Set
- Security Keep Included
- Security Keep, Round Adapters & Tension Bar Adapter Included with Round Kit
- Sized Appropriately to Gate. Specify:
 - > 4040 (1-1/2" to 2" Square, 1 5/8" Round Frame)
 - > 5050 (2" to 2-3/8" Square, 1 7/8" Round Frame)

Requires a 3 5/8" Spacing Between Gate Upright and 1st Picket



Round Adapters + Tension Bar Adapter

Description	Part no.	Weight ea.	Price
Silver Lock- Square	LUKY Kit Silver	6 lbs.	
Black Lock- Square	LUKY Kit Black	6 lbs.	
Silver Lock- Round	LUKY Kit Round Silver	6 lbs.	
Black Lock- Round	LUKY Kit Round Black	6 lbs.	

Blocking Knob

Aluminum Handle Blocking Set for LUKY Lock

- Allows the Following Functions:
 - > One Side Blocked or Eliminated, One Side Operational
 - > Both Sides Operational
 - > Both Sides Blocked
- Two Knobs, Two Shafts, Square Washers Included.



Description	Part no.	Weight ea.	Price
Blocking Knob Set	LOC3006KR	1 lb.	

◆ BorgLocks™ BL3400DKO (Single) / BL3430DKO (Dual) Kit

Mechanical Code Lock with Security Gate Keep/Stop

- No Battery, Fully Mechanical
- Single Access Code
- Combination Changed without Removing Lock from Gate
- Field Reversible
- Black, Marine Grade Finish
- Key Override, European Cylinder
- Breakaway Slip Clutch Lever
- Available with Single or Dual Sided Combination
- Security Keep Included
- Round Kit Includes Adapters

Requires a 3 5/8" Spacing Between Gate Upright and 1st Picket



Round Adapters

Description	Part no.	Weight ea.	Price
Single Side- Square	BL3400DKOKit	8 lbs.	
Single Side- Round	BL3400DKOKit-Round	8 lbs.	
Dual Side- Square	BL3430DKOKit	9 lbs.	
Dual Side- Round	BL3430DKOKit-Round	9 lbs.	

■ Ornamental Adapter

Lock Adapter Kit for Ornamental Gates

- Offers Easy, Finished Look for Locks Requiring First Picket to be Cut Out.
- 4-7/16" W x 9-1/2" H Inside Measurement
- Aluminum Construction with Black Powder Coat Finish. Color Matched Fasteners Included.

Description	Part no.	Weight ea.	Price
Ornamental Adapter	BL3400-ORN	1 lb.	



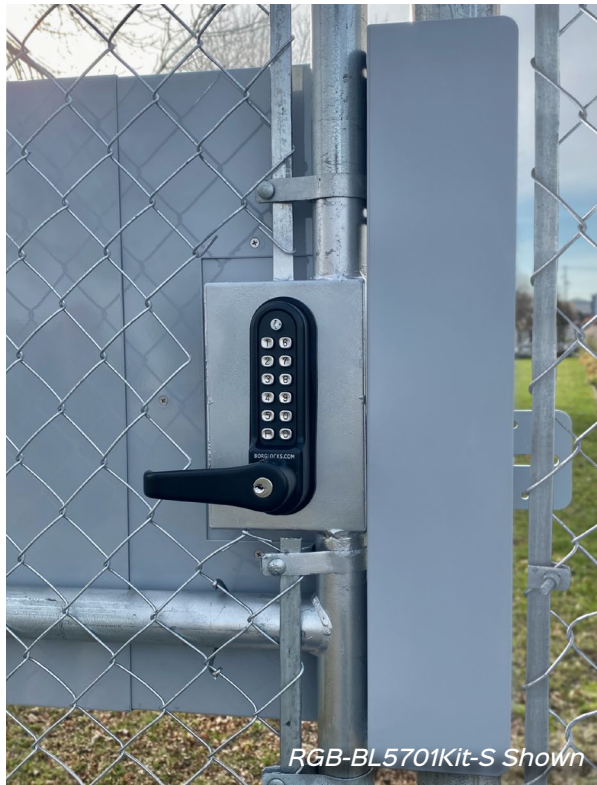

RGB-BL5701Kit-S Shown



RGB-BL5701Kit-S Shown

Rapid Gate Bundle

Three Piece Security Kit + Standalone Lever Lock Kit

- Quick, Easy Installation with Enhanced Security
- Security Plate Adjustable for Gates 31"-52" Wide, Cut out for Lock
 - 16 Gauge Electro-Galvanized Steel Accessories
 - Silver or Black Powder Coat Finish
 - Lever Guard Prevents Access to Lever
 - Latch Guard Provides Added Security Between Gate & Latch Post.
 - Designed for 3" Post; if 4" Needed, Must be Specified.
- Allows for 1 5/8" Min to 3" Max Latch Gap (When Using Standard 3" Post)

How To Order:

RGB + Lock Kit (includes box material & accessory color)

Ex: RGB-BL5701Kit-B

Adjustable
Security Plate

Lever
Guard

Latch
Guard



Lever Lock

Weldable
Gate Box

Adjustable
Receiver with Stop

*LUKY & BL3400DKO DO NOT REQUIRE WELD IN LOCK BOX AND INCLUDE LOCINOX SECURITY KEEP

To order call 616.235.0140
Email: info@dacindustries.com

#11190 Electric Strike Mounting Kit

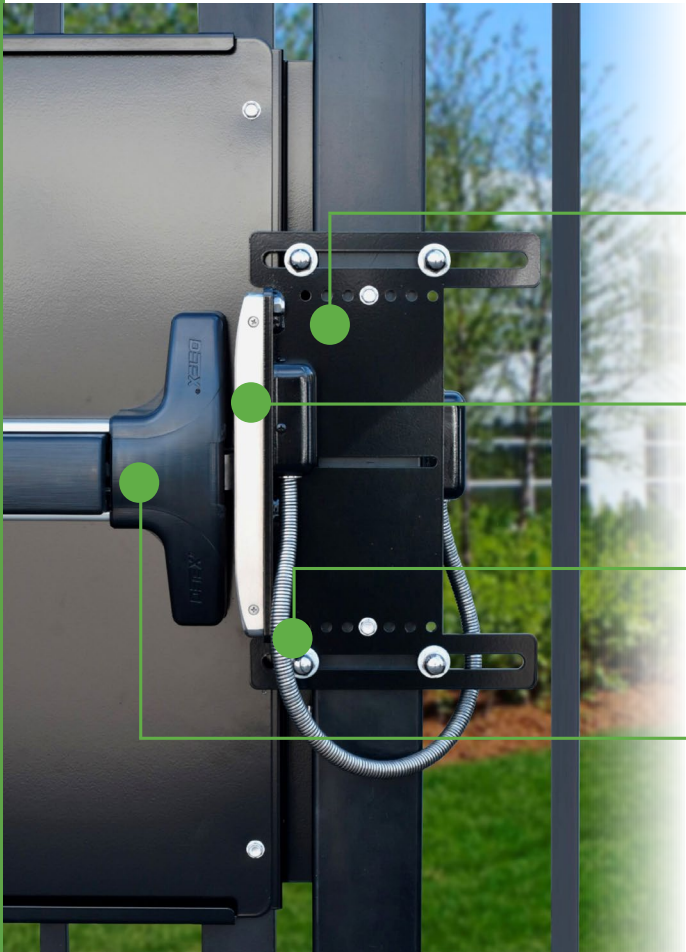

Adjustable bracket allows for easy, adjustable installation; no welding or fabricating required. Bracket acts as gate stop.

Outdoor rated electric strike is field selectable fail safe/fail secure, dual voltage 12/24V DC.

Stainless steel fasteners, flex conduit and connectors included.

Works with all DAC panic bar kits and exit devices. Ideal for adding access control to existing gates.

■ 11100 Electric Strike h.e.s.® 9600

- Surface Mounted
- Accommodates Rim Exit Devices with 3/4" Throw
- Stainless Steel Construction
- Outdoor Rated, Windstorm Rated
- Field Selectable Fail Safe or Fail Secure
- Field Selectable 12 or 24 Volt DC
- Field Reversible
- Satin Stainless Steel Finish

- ANSI/BHMA 156.31
- Grade 1
- UL Listed



Description	Part no.	Weight ea.	Price
Electric Strike	11100	1.75 lbs	

■ 11190 Mounting Kit for h.e.s.® 9600 Electric Strike with DAC Panic Bar Kits

- Easy, Adjustable Installation on Gates
- No Welding or Fabrication Required
- Mounting Bracket Acts as Gate Stop
- Adjustable for 5/8" to 2" Gap When Using Standard 3" Post
- Field Reversible
- 18" U.S. Stainless Steel Flex Conduit & Connectors Included
- Stainless Steel U-bolts Available for 2", 2 1/2", 3", 4" Round or Square Post
- h.e.s.® 9600 Electric Strike Included, See #11100 For Strike Features

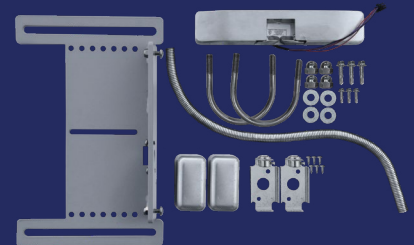

Description	Part no.	Weight ea.	Price
Mounting Kit with Electric Strike - Silver	11190-S	10 lbs.	
Mounting Kit with Electric Strike - Black	11190-B	10 lbs.	

6009 Detex® EAX-500W Door or Wall Mount Exit Alarm

- Battery Powered Alarm for Secured Doors or Square Gates
- Alarm Sounds with Unauthorized Exit
- 100 dB Alarm, Powered by a 9 Volt Battery, Low Battery Alert
- Includes Cylinder and Keys
- Tamper Resistant Housing
- Weatherized
- Available in Silver or Black

Description	Part no.	Weight ea.	Price
Battery Alarm Silver	6009-S	2 lbs.	
Battery Alarm Black	6009-B	2 lbs.	



6961 Detex® BE-961-1 Battery Eliminator

- Powers 9 Volt Security Devices Without Relying on Batteries
- Powers up to 3 Battery Operated Devices
- Compatible with 6006, 6008, 10006, 10008, 6009

Description	Part no.	Weight ea.	Price
Detex Battery Eliminator	6961	4 lbs.	



81-800 Detex® Power Supply

- Logic / Power Supply for Latch Retraction Exit Device
- Converts 120VAC into Regulated and Filtered 24VDC
- 1 AMP Continuous, Controls 1 Detex® Latch Retraction (ER) Device
- 18 Gauge Steel, Beige Box with Hinged Cover
- 12.25" High x 12.25" Wide x 3.5" Deep

Description	Part no.	Weight ea.	Price
Detex Power Supply	81-800	4lbs.	



FC3W/FC10W Detex® Flex Conduit

- Used to Protect Outdoor or Exposed Wires and Cables.
- Weatherized Flex Conduit Kit includes Conduit, Fittings and Waterproof Wire Nuts

Description	Part no.	Weight ea.	Price
3' Conduit Kit	FC3W	1 lbs.	
10' Conduit Kit	FC10W	1 lbs.	



11200 Securitron® M62FG-SASM Gate Magnalock®

- Holding Force 1200 lbs.
 - Shock Absorbing Strike Mount
 - Fully Sealed Electronics, Tamper Proof and Weatherproof
 - Patented Instant Release Circuit, No Residual Magnetism
 - Automatic Dual Voltage - 12/24VDC
 - Indoor or Outdoor Use
 - Bracket Kit Available (11010/11020)
- ANSI/BHMA 156.23
 - Grade 2
 - E08511-1000 Compliant
 - UL 10C Listed

Description	Part no.	Weight ea.	Price
Magnalock Gate Lock	11200	11.2 lbs.	



11000 Securitron® GL1 Gate Lock

- Holding Force 2000 lbs.
- Fail Locked (Remains Locked Without Power)
- Automatic Dual Voltage - 12/24VDC
- Self-Aligning Receiver
- Includes Cylinder and Keys
- Indoor or Outdoor Use
- Black Finish
- Bracket Kit Available (11010/11020)

Description	Part no.	Weight ea.	Price
Gate Lock, 12/24VDC	11000	5.5 lbs.	



11010/11020 Flex-Mount Bracket Kits

- Allows 11000 or 11200 to be Mounted Easily, Without Special Tools
- Mount on Fence or Gate Posts (Maximum 3" Round)
- Includes All Hardware and Post Shims
- Zinc Plated Steel
- Bolt-On or Weld

Description	Part no.	Weight ea.	Price
Flex-Mount Kit for Sliding Gate	11010	10.6 lbs.	
Flex-Mount Kit for Swing Gate	11020	13.5 lbs.	





DAC Industries, Inc. is a Michigan based manufacturer and supplier, providing high-quality gate hardware for the fencing industry since 1985. From gate latches to hinges, cantilever rollers to panic exit hardware, the knowledgeable staff at DAC Industries will meet your hardware needs and exceed your customer service expectations.

For over 40 years, DAC Industries has been developing its product line to meet the growing demands of the industry. A leader in hard to find hardware, DAC offers products built to the highest standards in the industry.



Grand Rapids, MI
Phone: 616.235.0140

Connect with us on social media: [f](#) [in](#)